

SERIE 2,8mm TERMINALI e CONNETTORI

.110" TERMINALS and CONNECTORS

TERMINALE FEMMINA 2,8x0,5
QUICK-CONNECT RECEPTACLE 2,8X0,5

 **UL Recognized** - DIN 46247 F.1

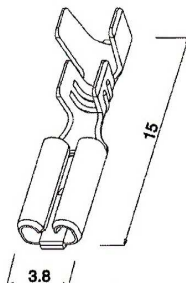

CODICE Code	SEZIONE CAVO Wire size		MATERIALE Material	TRATTAMENTO Treatment	CONFEZIONE Package	SPESSORE Thickness
	mm ²	AWG				
TF285201	0,25-0,5	23-20	Ottone / Brass	---	30.000	0,25
TF285202	0,25-0,5	23-20	Ottone / Brass	Stagnato / Tin plated	45.000	0,25
TF285311	0,5-1,5	20-15	Ottone / Brass	---	30.000	0,25
TF285312	0,5-1,5	20-15	Ottone / Brass	Stagnato / Tin plated	45.000	0,25

TERMINALE FEMMINA 2,8x0,8
QUICK-CONNECT RECEPTACLE 2,8X0,8

 **UL Recognized** - DIN 46247 F.1

TF288201	0,25-0,5	23-20	Ottone / Brass	---	30.000	0,30
TF288202	0,25-0,5	23-20	Ottone / Brass	Stagnato / Tin plated	45.000	0,30
TF288311	0,5-1,5	20-15	Ottone / Brass	---	30.000	0,30
TF288312	0,5-1,5	20-15	Ottone / Brass	Stagnato / Tin plated	45.000	0,30

TERMINALE FEMMINA 2,8X0,5 INSER.MORBIDO
QUICK-CONNECT RECEPTACLE 2,8X0,5 LOW INS.

 **UL Recognized**

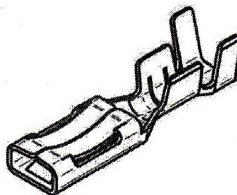

IM285311	0,5-1	20-17	Ottone / Brass	---	45.000	0,25
IM285312	0,5-1	20-17	Ottone / Brass	Pre Stagnato / Pre-tinned	45.000	0,25

TERMINALE FEMMINA 2,8X0,8 INSER.MORBIDO
QUICK-CONNECT RECEPTACLE 2,8X0,8 LOW INS.

 **UL Recognized**

IM288311	0,5-1	20-17	Ottone / Brass	---	45.000	0,25
IM288312	0,5-1	20-17	Ottone / Brass	Pre Stagnato / Pre-tinned	45.000	0,25

SERIE 2,8mm TERMINALI e CONNETTORI .110" TERMINALS and CONNECTORS

COPRIFASTON FEMMINA CONNECTOR FOR RECEPTACLE

 UL Recognized

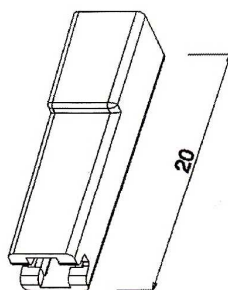

2,8 x 0,5
2,8 x 0,8



2,8 x 0,5
2,8 x 0,8

CODICE Code	CONFEZIONE Package	COLORE Colour	MATERIALE Material	INFIAMMABILITA' Flammability	
CT1004	40.000	Neutro / Neutral	Nylon 66	UL94-V2	--
CT1004-1	40.000	Nero / Black	Nylon 66	UL94-V2	--
CT1004-2	40.000	Rosso / Red	Nylon 66	UL94-V2	--
CT1004-3	40.000	Verde / Green	Nylon 66	UL94-V2	--
CT1004-4	40.000	Giallo / Yellow	Nylon 66	UL94-V2	--
CT1004-5	40.000	Blu / Blue	Nylon 66	UL94-V2	--
CT1004H	40.000	Neutro / Neutral	Nylon 66	UL94-V2	GWT NoFlame
CT1004H1	40.000	Nero / Black	Nylon 66	UL94-V2	GWT NoFlame
CT1004H2	40.000	Rosso / Red	Nylon 66	UL94-V2	GWT NoFlame
CT1004H3	40.000	Verde / Green	Nylon 66	UL94-V2	GWT NoFlame
CT1004H4	40.000	Giallo / Yellow	Nylon 66	UL94-V2	GWT NoFlame
CT1004H5	40.000	Blu / Blue	Nylon 66	UL94-V2	GWT NoFlame
CT1004V0	40.000	Neutro / Neutral	Nylon 66	UL94-V0	RTI 110
CT1004Z	40.000	Neutro / Neutral	Nylon 66	UL94-V0	GWT NoFlame
CT1004Z1	40.000	Nero / Black	Nylon 66	UL94-V0	GWT NoFlame
CT1004Z2	40.000	Rosso / Red	Nylon 66	UL94-V0	GWT NoFlame
CT1004V	40.000	Neutro / Neutral	Nylon 46	UL94-V2	RTI120 / RTI-EI 150

SERIE 2,8mm TERMINALI e CONNETTORI .110" TERMINALS and CONNECTORS

COPRIFASTON FEMMINA - Per inseritrice automatica
CONNECTOR FOR RECEPTACLE - For automatic machine

 **UL Recognized**

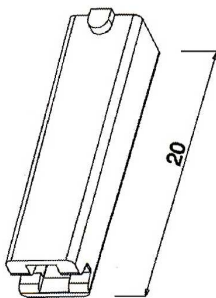

2,8 x 0.5
2,8 x 0.8



2,8 x 0.5
2,8 x 0.8

CODICE Code	CONFEZIONE Package	COLORE Colour	MATERIALE Material	INFIAMMABILITA' Flammability	
CT1004B	40.000	Neutro / Neutral	Nylon 66	UL94-V2	--
CT1004B1	40.000	Nero / Black	Nylon 66	UL94-V2	--
CT1004B2	40.000	Rosso / Red	Nylon 66	UL94-V2	--
CT1004B3	40.000	Verde / Green	Nylon 66	UL94-V2	--
CT1004B4	40.000	Giallo / Yellow	Nylon 66	UL94-V2	--
CT1004B5	40.000	Blu / Blue	Nylon 66	UL94-V2	--
CT1004BH	40.000	Neutro / Neutral	Nylon 66	UL94-V2	GWT NoFlame
CT1004BH1	40.000	Nero / Black	Nylon 66	UL94-V2	GWT NoFlame
CT1004BH2	40.000	Rosso / Red	Nylon 66	UL94-V2	GWT NoFlame
CT1004BH3	40.000	Verde / Green	Nylon 66	UL94-V2	GWT NoFlame
CT1004BH4	40.000	Giallo / Yellow	Nylon 66	UL94-V2	GWT NoFlame
CT1004BH5	40.000	Blu / Blue	Nylon 66	UL94-V2	GWT NoFlame
CT1004BV0	40.000	Neutro / Neutral	Nylon 66	UL94-V0	RTI 110
CT1004BZ	40.000	Neutro / Neutral	Nylon 66	UL94-V0	GWT NoFlame
CT1004BZ1	40.000	Nero / Black	Nylon 66	UL94-V0	GWT NoFlame
CT1004BZ2	40.000	Rosso / Red	Nylon 66	UL94-V0	GWT NoFlame
CT1004BV	40.000	Neutro / Neutral	Nylon 46	UL94-V2	RTI120 / RTI-EI 150

SERIE 2,8mm TERMINALI e CONNETTORI

.110" TERMINALS and CONNECTORS

COPRIFASTON FEMMINA CONNECTOR FOR RECEPTACLE

 UL Recognized

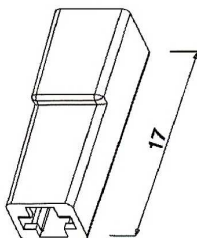

2,8 x 0.5
2,8 x 0.8



2,8 x 0.5
2,8 x 0.8

CODICE Code	CONFEZIONE Package	COLORE Colour	MATERIALE Material	INFIAMMABILITA' Flammability	
CT1004C	40.000	Neutro / Neutral	Nylon 66	UL94-V2	--
CT1004C1	40.000	Nero / Black	Nylon 66	UL94-V2	--
CT1004C2	40.000	Rosso / Red	Nylon 66	UL94-V2	--
CT1004C3	40.000	Verde / Green	Nylon 66	UL94-V2	--
CT1004C4	40.000	Giallo / Yellow	Nylon 66	UL94-V2	--
CT1004C5	40.000	Blu / Blue	Nylon 66	UL94-V2	--
CT1004CH	40.000	Neutro / Neutral	Nylon 66	UL94-V2	GWT NoFlame
CT1004CH1	40.000	Nero / Black	Nylon 66	UL94-V2	GWT NoFlame
CT1004CH2	40.000	Rosso / Red	Nylon 66	UL94-V2	GWT NoFlame
CT1004CH3	40.000	Verde / Green	Nylon 66	UL94-V2	GWT NoFlame
CT1004CH4	40.000	Giallo / Yellow	Nylon 66	UL94-V2	GWT NoFlame
CT1004CH5	40.000	Blu / Blue	Nylon 66	UL94-V2	GWT NoFlame
CT1004CV0	40.000	Neutro / Neutral	Nylon 66	UL94-V0	RTI 110
CT1004CZ	40.000	Neutro / Neutral	Nylon 66	UL94-V0	GWT NoFlame
CT1004CZ1	40.000	Nero / Black	Nylon 66	UL94-V0	GWT NoFlame
CT1004CZ2	40.000	Rosso / Red	Nylon 66	UL94-V0	GWT NoFlame
CT1004CV	40.000	Neutro / Neutral	Nylon 46	UL94-V2	RTI120 / RTI-EI 150

SERIE 2,8mm TERMINALI e CONNETTORI

.110" TERMINALS and CONNECTORS

COPRIFASTON FEMMINA - Per inseritrice automatica
CONNECTOR FOR RECEPTACLE - For automatic machine

 **UL Recognized**

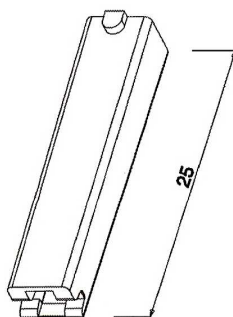

2,8 x 0.5
2,8 x 0.8



2,8 x 0.5
2,8 x 0.8

CODICE Code	CONFEZIONE Package	COLORE Colour	MATERIALE Material	INFIAMMABILITA' Flammability	
CT1004L	40.000	Neutro / Neutral	Nylon 66	UL94-V2	--
CT1004L1	40.000	Nero / Black	Nylon 66	UL94-V2	--
CT1004L2	40.000	Rosso / Red	Nylon 66	UL94-V2	--
CT1004L3	40.000	Verde / Green	Nylon 66	UL94-V2	--
CT1004L4	40.000	Giallo / Yellow	Nylon 66	UL94-V2	--
CT1004L5	40.000	Blu / Blue	Nylon 66	UL94-V2	--
CT1004LH	40.000	Neutro / Neutral	Nylon 66	UL94-V2	GWT NoFlame
CT1004LH1	40.000	Nero / Black	Nylon 66	UL94-V2	GWT NoFlame
CT1004LH2	40.000	Rosso / Red	Nylon 66	UL94-V2	GWT NoFlame
CT1004LH3	40.000	Verde / Green	Nylon 66	UL94-V2	GWT NoFlame
CT1004LH4	40.000	Giallo / Yellow	Nylon 66	UL94-V2	GWT NoFlame
CT1004LH5	40.000	Blu / Blue	Nylon 66	UL94-V2	GWT NoFlame
CT1004LV0	40.000	Neutro / Neutral	Nylon 66	UL94-V0	RTI 110
CT1004LZ	40.000	Neutro / Neutral	Nylon 66	UL94-V0	GWT NoFlame
CT1004LZ1	40.000	Nero / Black	Nylon 66	UL94-V0	GWT NoFlame
CT1004LZ2	40.000	Rosso / Red	Nylon 66	UL94-V0	GWT NoFlame
CT1004LV	40.000	Neutro / Neutral	Nylon 46	UL94-V2	RTI120 / RTI-EI 150

SERIE 2,8mm TERMINALI e CONNETTORI

.110" TERMINALS and CONNECTORS

COPRIFASTON FEMMINA - Per inseritrice automatica

CONNECTOR FOR RECEPTACLE - For automatic machine

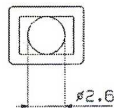

2,8 x 0.5
2,8 x 0.8



2,8 x 0.5
2,8 x 0.8

CODICE Code	CONFEZIONE Package	COLORE Colour	MATERIALE Material	INFIAMMABILITA' Flammability	
				UL94-V1	--
CT1004PE	30.000	Neutro /Neutral	Polyetilene	UL94-V1	--
CT1004PE1	30.000	Nero / Black	Polyetilene	UL94-V1	--

SERIE 4,8mm TERMINALI e CONNETTORI .187" TERMINALS and CONNECTORS

TERMINALE FEMMINA 4,8x0,5 QUICK-CONNECT RECEPTACLE 4,8X0,5

 UL Recognized - DIN 46247 F.2

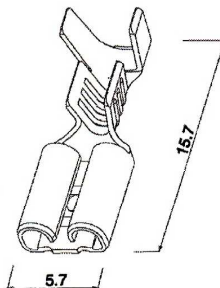

CODICE Code	SEZIONE CAVO Wire size		MATERIALE Material	TRATTAMENTO Treatment	CONFEZIONE Package	SPESSORE Thickness
	mm ²	AWG				
TF485221	0,5-1	20-17	Ottone / Brass	---	20.000	0,32
TF485222	0,5-1	20-17	Ottone / Brass	Stagnato / Tin plated	30.000	0,32
TF485225	0,5-1	20-17	Acciaio / Steel	Nichelato / Nickeled	20.000	0,32
TF485421	0,5-2	20-14	Ottone / Brass	---	20.000	0,32
TF485422	0,5-2	20-14	Ottone / Brass	Stagnato / Tin plated	30.000	0,32
TF485425	0,5-2	20-14	Acciaio / Steel	Nichelato / Nickeled	20.000	0,32

TERMINALE FEMMINA 4,8x0,8 QUICK-CONNECT RECEPTACLE 4,8X0,8

 UL Recognized - DIN 46247 F.1

CODICE Code	SEZIONE CAVO Wire size		MATERIALE Material	TRATTAMENTO Treatment	CONFEZIONE Package	SPESSORE Thickness
	mm ²	AWG				
TF488221	0,5-1	20-17	Ottone / Brass	---	20.000	0,32
TF488222	0,5-1	20-17	Ottone / Brass	Stagnato / Tin plated	30.000	0,32
TF488225	0,5-1	20-17	Acciaio / Steel	Nichelato / Nickeled	20.000	0,32
TF488421	0,5-2	20-14	Ottone / Brass	---	20.000	0,32
TF488422	0,5-2	20-14	Ottone / Brass	Stagnato / Tin plated	30.000	0,32
TF488425	0,5-2	20-14	Acciaio / Steel	Nichelato / Nickeled	20.000	0,32

SERIE 4,8mm TERMINALI e CONNETTORI

.187" TERMINALS and CONNECTORS

COPRIFASTON FEMMINA CONNECTOR FOR RECEPTACLE

 UL Recognized

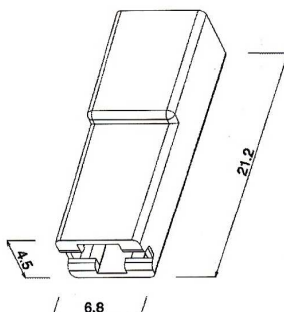

4,8 x 0,5
4,8 x 0,8

CODICE Code	CONFEZIONE Package	COLORE Colour	MATERIALE Material	INFIAMMABILITA' Flammability	
CT1012	25.000	Neutro / Neutral	Nylon 66	UL94-V2	--
CT1012-1	25.000	Nero / Black	Nylon 66	UL94-V2	--
CT1012-2	25.000	Rosso / Red	Nylon 66	UL94-V2	--
CT1012-3	25.000	Verde / Green	Nylon 66	UL94-V2	--
CT1012-4	25.000	Giallo / Yellow	Nylon 66	UL94-V2	--
CT1012-5	25.000	Blu / Blue	Nylon 66	UL94-V2	--
CT1012H	25.000	Neutro / Neutral	Nylon 66	UL94-V2	GWT NoFlame
CT1012H1	25.000	Nero / Black	Nylon 66	UL94-V2	GWT NoFlame
CT1012H2	25.000	Rosso / Red	Nylon 66	UL94-V2	GWT NoFlame
CT1012H3	25.000	Verde / Green	Nylon 66	UL94-V2	GWT NoFlame
CT1012H4	25.000	Giallo / Yellow	Nylon 66	UL94-V2	GWT NoFlame
CT1012H5	25.000	Blu / Blue	Nylon 66	UL94-V2	GWT NoFlame
CT1012V0	25.000	Neutro / Neutral	Nylon 66	UL94-V0	RTI 110
CT1012Z	25.000	Neutro / Neutral	Nylon 66	UL94-V0	GWT NoFlame
CT1012Z1	25000	Nero / Black	Nylon 66	UL94-V0	GWT NoFlame
CT1012Z2	25.000	Rosso / Red	Nylon 66	UL94-V0	GWT NoFlame
CT1012V	25.000	Neutro / Neutral	Nylon 46	UL94-V2	RTI120 / RTI-EI 150

SERIE 4,8mm TERMINALI e CONNETTORI

.187" TERMINALS and CONNECTORS

COPRIFASTON FEMMINA CONNECTOR FOR RECEPTACLE

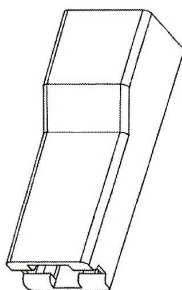

4,8 x 0,5
4,8 x 0,8

CODICE Code	CONFEZIONE Package	COLORE Colour	MATERIALE Material	INFIAMMABILITA' Flammability	
CT1012D	25.000	Neutro /Neutral	Nylon 66	UL94-V2	--
CT1012D1	25.000	Nero / Black	Nylon 66	UL94-V2	--
CT1012DH	25.000	Neutro /Neutral	Nylon 66	UL94-V2	GWT NoFlame
CT1012DH1	25.000	Nero / Black	Nylon 66	UL94-V2	GWT NoFlame
CT1012DV0	25.000	Giallo / Yellow	Nylon 66	UL94-V0	RTI 110

COPRIFASTON FEMMINA CONNECTOR FOR RECEPTACLE

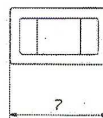
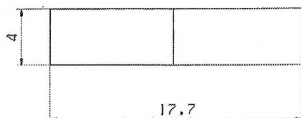

4,8 x 0,5
4,8 x 0,8



CODICE Code	CONFEZIONE Package	COLORE Colour	MATERIALE Material	INFIAMMABILITA' Flammability	
CT1012PE	30.000	Neutro /Neutral	Nylon 66	UL94-V2	--
CT101PE1	30.000	Nero / Black	Nylon 66	UL94-V2	--

SERIE 4,8mm TERMINALI e CONNETTORI

.187" TERMINALS and CONNECTORS

TERMINALE FEMMINA 4,8x0,5 - ANTIFILAMENTO

QUICK-CONNECT RECEPTACLE 4,8X0,5 - SELF LOCKING

 UL Recognized

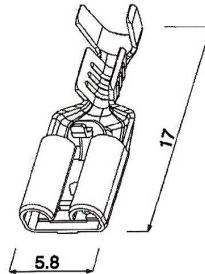

CODICE Code	SEZIONE CAVO Wire size		MATERIALE Material	TRATTAMENTO Treatment	CONFEZIONE Package	SPESSORE Thickness
	mm ²	AWG				
AS485221	0,5-1	20-17	Ottone / Brass	---	24.000	0,35
AS485223	0,5-1	20-17	Ottone / Brass	Pre stagnato/PreTinned	24.000	0,35
AS485421	0,5-2	20-14	Ottone / Brass	---	21.000	0,35
AS485423	0,5-2	20-14	Ottone / Brass	Pre stagnato/PreTinned	21.000	0,35

TERMINALE FEMMINA 4,8x0,8 - ANTIFILAMENTO

QUICK-CONNECT RECEPTACLE 4,8X0,8 - SELF LOCKING

 UL Recognized

CODICE Code	SEZIONE CAVO Wire size		MATERIALE Material	TRATTAMENTO Treatment	CONFEZIONE Package	SPESSORE Thickness
	mm ²	AWG				
AS488221	0,5-1	20-17	Ottone / Brass	---	24.000	0,35
AS488222	0,5-1	20-17	Ottone / Brass	Pre stagnato/PreTinned	24.000	0,35
AS488421	0,5-2	20-14	Ottone / Brass	---	21.000	0,35
AS488422	0,5-2	20-14	Ottone / Brass	Pre stagnato/PreTinned	21.000	0,35

SERIE 4,8mm TERMINALI e CONNETTORI .187" TERMINALS and CONNECTORS

COPRIFASTON FEMMINA CONNECTOR FOR RECEPTACLE

 UL Recognized

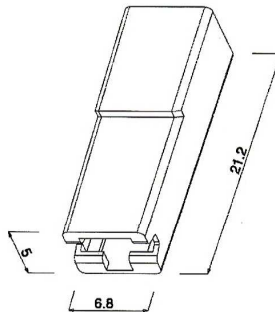

4,8 x 0,5
4,8 x 0,8

CODICE Code	CONFEZIONE Package	COLORE Colour	MATERIALE Material	INFIAMMABILITA' Flammability	
CT1013	25.000	Neutro / Neutral	Nylon 66	UL94-V2	--
CT1013-1	25.000	Nero / Black	Nylon 66	UL94-V2	--
CT1013-2	25.000	Rosso / Red	Nylon 66	UL94-V2	--
CT1013-3	25.000	Verde / Green	Nylon 66	UL94-V2	--
CT1013-4	25.000	Giallo / Yellow	Nylon 66	UL94-V2	--
CT1013-5	25.000	Blu / Blue	Nylon 66	UL94-V2	--
CT1013H	25.000	Neutro / Neutral	Nylon 66	UL94-V2	GWT NoFlame
CT1013H1	25.000	Nero / Black	Nylon 66	UL94-V2	GWT NoFlame
CT1013H2	25.000	Rosso / Red	Nylon 66	UL94-V2	GWT NoFlame
CT1012H3	25.000	Verde / Green	Nylon 66	UL94-V2	GWT NoFlame
CT1013H4	25.000	Giallo / Yellow	Nylon 66	UL94-V2	GWT NoFlame
CT1013H5	25.000	Blu / Blue	Nylon 66	UL94-V2	GWT NoFlame
CT1013V0	25.000	Neutro / Neutral	Nylon 66	UL94-V0	RTI 110
CT1013Z	25.000	Neutro / Neutral	Nylon 66	UL94-V0	GWT NoFlame
CT1013Z1	25.000	Nero / Black	Nylon 66	UL94-V0	GWT NoFlame
CT1013Z2	25.000	Rosso / Red	Nylon 66	UL94-V0	GWT NoFlame
CT1013V	25.000	Neutro / Neutral	Nylon 46	UL94-V2	RTI120 / RTI-EI 150

SERIE 4,8mm TERMINALI e CONNETTORI .187" TERMINALS and CONNECTORS

TERMINALE FEMMINA 4,8x0,5 ROLLATO QUICK-CONNECT SHORT FLAG RECEPTACLE 4,8X0,5

CODICE Code	SEZIONE CAVO Wire size		MATERIALE Material	TRATTAMENTO Treatment	CONFEZIONE Package	SPESSORE Thickness
	mm ²	AWG				
TR485221	0,5-1	20-17	Ottone / Brass	---	24.000	0,35
TR485223	0,5-1	20-17	Ottone / Brass	Pre stagnato/PreTinned	24.000	0,35
TR485421	0,5-2	20-14	Ottone / Brass	---	21.000	0,35
TR485423	0,5-2	20-14	Ottone / Brass	Pre stagnato/PreTinned	21.000	0,35

TERMINALE FEMMINA 4,8x0,8 ROLLATO QUICK-CONNECT SHORT FLAG RECEPTACLE 4,8X0,8

CODICE Code	SEZIONE CAVO Wire size		MATERIALE Material	TRATTAMENTO Treatment	CONFEZIONE Package	SPESSORE Thickness
	mm ²	AWG				
TR488221	0,5-1	20-17	Ottone / Brass	---	24.000	0,35
TR488222	0,5-1	20-17	Ottone / Brass	Pre stagnato/PreTinned	24.000	0,35
TR488421	0,5-2	20-14	Ottone / Brass	---	21.000	0,35
TR488422	0,5-2	20-14	Ottone / Brass	Pre stagnato/PreTinned	21.000	0,35

SERIE 4,8mm TERMINALI e CONNETTORI .187" TERMINALS and CONNECTORS

COPRIFASTON FEMMINA ROLLATO CONNECTOR FOR SHORT FLAG RECEPTACLE

 UL Recognized

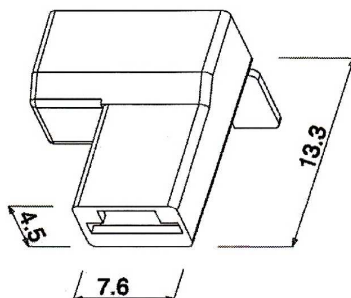

4,8 x 0,5
4,8 x 0,8

CODICE Code	CONFEZIONE Package	COLORE Colour	MATERIALE Material	INFIAMMABILITA' Flammability	
CT1009C	25.000	Neutro / Neutral	Nylon 66	UL94-V2	--
CT1009C1	25.000	Nero / Black	Nylon 66	UL94-V2	--
CT1009C2	25.000	Rosso / Red	Nylon 66	UL94-V2	GWT NoFlame
CT1009CH	25.000	Neutro / Neutral	Nylon 66	UL94-V2	GWT NoFlame
CT1009CV0	25.000	Giallo / Yellow	Nylon 66	UL94-V0	RTI 110

SERIE 6,3mm TERMINALI e CONNETTORI

.250" TERMINALS and CONNECTORS

TERMINALE MASCHIO 6,3x0,8
QUICK-CONNECT TAB 6,3X0,8

 **UL Recognized - DIN 46248 F.3**

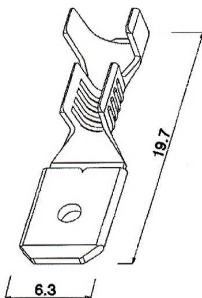

CODICE Code	SEZIONE CAVO Wire size		MATERIALE Material	TRATTAMENTO Treatment	CONFEZIONE Package	SPESSORE Thickness
	mm ²	AWG				
TM638531	1-2,5	17-13	Ottone / Brass	---	10.000	0,42
TM638532	1-2,5	17-13	Ottone / Brass	Stagnato / Tin plated	10.000	0,42
TM638535	1-2,5	17-13	Acciaio / Steel	Nichelato / Nickerled	10.000	0,42

SERIE 6,3mm TERMINALI e CONNETTORI .250" TERMINALS and CONNECTORS

COPRIFASTON POSTERIORE PER TERMINALE MASCHIO BACK INSERTION CONNECTOR FOR QUICK-CONNECT TAB

 UL Recognized

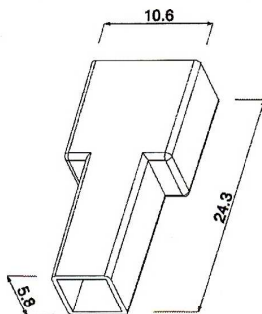

6,3 x 0,8

CODICE Code	CONFEZIONE Package	COLORE Colour	MATERIALE Material	INFIAMMABILITA' Flammability	
CT1003N	20.000	Neutro / Neutral	Nylon 66	UL94-V2	--
CT1003N1	20.000	Nero / Black	Nylon 66	UL94-V2	--
CT1003N2	20.000	Rosso / Red	Nylon 66	UL94-V2	--
CT1003NH	20.000	Neutro / Neutral	Nylon 66	UL94-V2	GWT NoFlame
CT1003NH1	20.000	Nero / Black	Nylon 66	UL94-V2	GWT NoFlame
CT1003NH2	20.000	Rosso / Red	Nylon 66	UL94-V2	GWT NoFlame
CT1003NV0	20.000	Neutro / Neutral	Nylon 66	UL94-V0	RTI 110
CT1003NZ	20.000	Neutro / Neutral	Nylon 66	UL94-V0	GWT NoFlame
CT1003NV	20.000	Neutro / Neutral	Nylon 66	UL94-V2	RTI120 - RTI Elec150

 UL Recognized

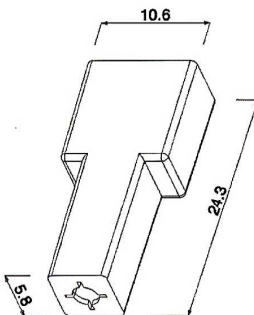

6,3 x 0,8

CODICE Code	CONFEZIONE Package	COLORE Colour	MATERIALE Material	INFIAMMABILITA' Flammability	
CT1103N	20.000	Neutro / Neutral	Nylon 66	UL94-V2	--
CT1103N1	20.000	Nero / Black	Nylon 66	UL94-V2	--
CT1103N2	20.000	Rosso / Red	Nylon 66	UL94-V2	--
CT1103NH	20.000	Neutro / Neutral	Nylon 66	UL94-V2	GWT NoFlame
CT1103NH1	20.000	Nero / Black	Nylon 66	UL94-V2	GWT NoFlame
CT1103NH2	20.000	Rosso / Red	Nylon 66	UL94-V2	GWT NoFlame
CT1103NV0	20.000	Neutro / Neutral	Nylon 66	UL94-V0	RTI 110
CT1103NZ	20.000	Neutro / Neutral	Nylon 66	UL94-V0	GWT NoFlame
CT1103NV	20.000	Neutro / Neutral	Nylon 66	UL94-V2	RTI120 - RTI Elec150

SERIE 6,3mm TERMINALI e CONNETTORI .250" TERMINALS and CONNECTORS

COPRIFASTON POSTERIORE PER TERMINALE MASCHIO

Inserimento frontale dopo aggraffatura

BACK INSERTION CONNECTOR FOR QUICK-CONNECT TAB

Straight insertion after crimping

 UL Recognized

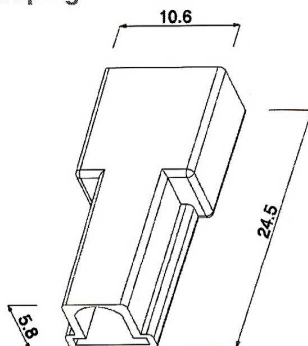

6,3 x 0,8

CODICE Code	CONFEZIONE Package	COLORE Colour	MATERIALE Material	INFIAMMABILITA' Flammability	
CT1003M	20.000	Neutro / Neutral	Nylon 66	UL94-V2	--
CT1003M1	20.000	Nero / Black	Nylon 66	UL94-V2	--
CT1003M2	20.000	Rosso / Red	Nylon 66	UL94-V2	--
CT1003MH	20.000	Neutro / Neutral	Nylon 66	UL94-V2	GWT NoFlame
CT1003MH1	20.000	Nero / Black	Nylon 66	UL94-V2	GWT NoFlame
CT1003MH2	20.000	Rosso / Red	Nylon 66	UL94-V2	GWT NoFlame
CT1003MV0	20.000	Neutro / Neutral	Nylon 66	UL94-V0	RTI 110
CT1003MZ	20.000	Neutro / Neutral	Nylon 66	UL94-V0	GWT NoFlame
CT1003MV	20.000	Neutro / Neutral	Nylon 66	UL94-V2	RTI120 - RTI Elec150

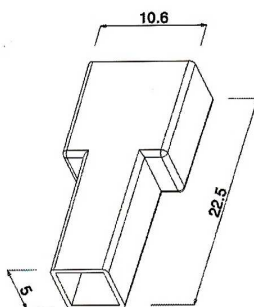

6,3 x 0,8

CODICE Code	CONFEZIONE Package	COLORE Colour	MATERIALE Material	INFIAMMABILITA' Flammability	
CT1003PE	20.000	Neutro / Neutral	Polyetilene	UL94-V1	--
CT1003PE1	20.000	Nero / Black	Polyetilene	UL94-V1	--
CT1003PE2	20.000	Rosso / Red	Polyetilene	UL94-V1	--

SERIE 6,3mm TERMINALI e CONNETTORI .250" TERMINALS and CONNECTORS

TERMINALE FEMMINA 6,3x0,8
QUICK-CONNECT RECEPTACLE 6,3X0,8

 UL Recognized - DIN 46247 F.3

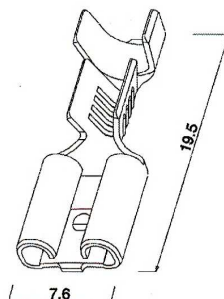

CODICE Code	SEZIONE CAVO Wire size		MATERIALE Material	TRATTAMENTO Treatment	CONFEZIONE Package	SPESSORE Thickness
	mm ²	AWG				
TF638241	0,5-1	20-17	Ottone / Brass	---	10.000	0,42
TF638242	0,5-1	20-17	Ottone / Brass	Stagnato / Tin plated	14.000	0,42
TF638245	0,5-1	20-17	Acciaio / Steel	Nichelato / Nickeled	10.000	0,42
TF638541	1-2,5	17-13	Ottone / Brass	---	10.000	0,42
TF638542	1-2,5	17-13	Ottone / Brass	Stagnato / Tin plated	13.000	0,42
TF638545	1-2,5	17-13	Acciaio / Steel	Nichelato / Nickeled	10.000	0,42

TERMINALE FEMMINA + MASCHIO 6,3x0,8
QUICK-CONNECT RECEPTACLE + TAB 6,3X0,8

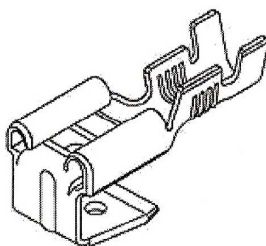

CODICE Code	SEZIONE CAVO Wire size		MATERIALE Material	TRATTAMENTO Treatment	CONFEZIONE Package	SPESSORE Thickness
	mm ²	AWG				
PB638241	0,5-1	20-17	Ottone / Brass	---	9.000	0,4
PB638243	0,5-1	20-17	Ottone / Brass	Pre stagnato Pre-tinned	9.000	0,4
PB638541	0,75-2	18-14	Ottone / Brass	---	9.000	0,4
PB638543	0,75-2	18-14	Ottone / Brass	Pre stagnato Pre-tinned	9.000	0,4

SERIE 6,3mm TERMINALI e CONNETTORI .250" TERMINALS and CONNECTORS

TERMINALE FEMMINA 6,3x0,8

EXTRA STRONG

QUICK-CONNECT RECEPTACLE 6,3X0,8

EXTRA STRONG

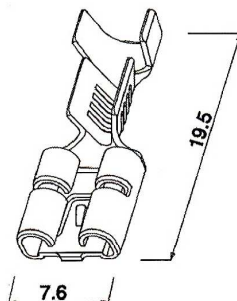

CODICE Code	SEZIONE CAVO Wire size		MATERIALE Material	TRATTAMENTO Treatment	CONFEZIONE Package	SPESSORE Thickness
	mm ²	AWG				
OL638241	0,5-1	20-17	Ottone / Brass	---	10.000	0,42
OL638541	1-2,5	17-13	Ottone / Brass	---	10.000	0,42

SERIE 6,3mm TERMINALI e CONNETTORI .250" TERMINALS and CONNECTORS

COPRIFASTON POSTERIORE PER TERMINALE FEMMINA BACK CONNECTOR FOR QUICK-CONNECT RECEPTACLES

 UL Recognized

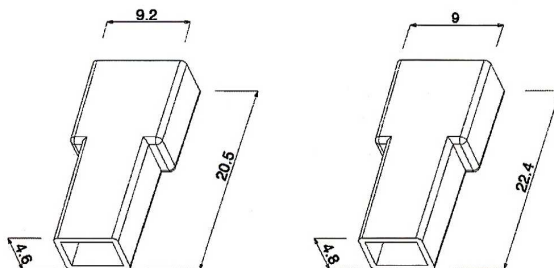

6,3 x 0,8



6,3 x 0,8



6,3 x 0,8

CT1001PE

CODICE Code	CONFEZIONE Package	COLORE Colour	MATERIALE Material	INFIAMMABILITA' Flammability	
CT1001N	20.000	Neutro / Neutral	Nylon 66	UL94-V2	--
CT1001N1	20.000	Nero / Black	Nylon 66	UL94-V2	--
CT1001N2	20.000	Rosso / Red	Nylon 66	UL94-V2	--
CT1001NH	20.000	Neutro / Neutral	Nylon 66	UL94-V2	GWT NoFlame
CT1001NVO	20.000	Neutro / Neutral	Nylon 66	UL94-V0	RTI 110
CT1001NZ	20.000	Neutro / Neutral	Nylon 66	UL94-V0	GWT NoFlame
CT1001NV	20.000	Neutro / Neutral	Nylon 66	UL94-V2	RTI120 - RTI Elec150
CT1001PE	20.000	Neutro / Neutral	Polyetilene	UL94-V1	--
CT1001PE1	20.000	Nero / Black	Polyetilene	UL94-V1	--

COPRIFASTON PER TERMINALE FEMMINA CONNECTOR FOR QUICK-CONNECT RECEPTACLE

 UL Recognized

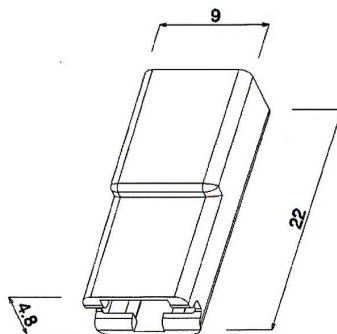

6,3 x 0,8



6,3 x 0,8

CODICE Code	CONFEZIONE Package	COLORE Colour	MATERIALE Material	INFIAMMABILITA' Flammability	
CT1002	20.000	Neutro / Neutral	Nylon 66	UL94-V2	--
CT1002-1	20.000	Nero / Black	Nylon 66	UL94-V2	--
CT1002-2	20.000	Rosso / Red	Nylon 66	UL94-V2	--
CT1002H	20.000	Neutro / Neutral	Nylon 66	UL94-V2	GWT NoFlame
CT1002V0	20.000	Neutro / Neutral	Nylon 66	UL94-V0	RTI 110
CT1002Z	20.000	Neutro / Neutral	Nylon 66	UL94-V0	GWT NoFlame
CT1002V	20.000	Neutro / Neutral	Nylon 66	UL94-V2	RTI120 / RTI-EI 150

SERIE 6,3mm TERMINALI e CONNETTORI

.250" TERMINALS and CONNECTORS

COPRIFASTON PER TERMINALE FEMMINA

Per inseritrice automatica - Strong 150N

CONNECTOR FOR QUICK-CONNECT RECEPTACLE

For automatic machine - Strong 150N

 UL Recognized

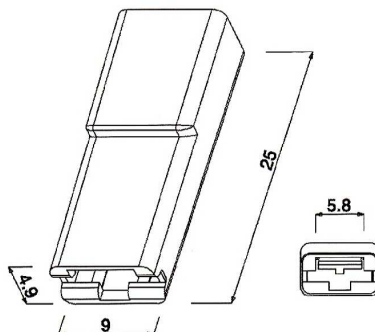

6,3 x 0,8



6,3 x 0,8

CODICE Code	CONFEZIONE Package	COLORE Colour	MATERIALE Material	INFIAMMABILITA' Flammability	
CT2002A	20.000	Neutro / Neutral	Nylon 66	UL94-V2	--
CT2002A1	20.000	Nero / Black	Nylon 66	UL94-V2	--
CT2002A2	20.000	Rosso / Red	Nylon 66	UL94-V2	--
CT2002A3	20.000	Verde / Green	Nylon 66	UL94-V2	--
CT2002A4	20.000	Giallo / Yellow	Nylon 66	UL94-V2	--
CT2002A5	20.000	Blu / Blue	Nylon 66	UL94-V2	--
CT2002AH1	20.000	Neutro / Neutral	Nylon 66	UL94-V2	GWT NoFlame
CT2002AH2	20.000	Nero / Black	Nylon 66	UL94-V2	GWT NoFlame
CT2002AH3	20.000	Rosso / Red	Nylon 66	UL94-V2	GWT NoFlame
CT2002AH4	20.000	Verde / Green	Nylon 66	UL94-V2	GWT NoFlame
CT2002AH5	20.000	Giallo / Yellow	Nylon 66	UL94-V2	GWT NoFlame
CT2002AH1	20.000	Blu / Blue	Nylon 66	UL94-V2	GWT NoFlame
CT2002AV0	20.000	Neutro / Neutral	Nylon 66	UL94-V0	RTI 110
CT2002AZ	20.000	Neutro / Neutral	Nylon 66	UL94-V0	GWT NoFlame
CT2002AZ1	20.000	Nero / Black	Nylon 66	UL94-V0	GWT NoFlame
CT2002AZ2	20.000	Rosso / Red	Nylon 66	UL94-V0	GWT NoFlame
CT2002AV	20.000	Neutro / Neutral	Nylon 46	UL94-V2	RTI120 / RTI-EI 150

SERIE 6,3mm TERMINALI e CONNETTORI .250" TERMINALS and CONNECTORS

COPRIFASTON PER TERMINALE FEMMINA

Per inseritrice automatica

CONNECTOR FOR QUICK-CONNECT RECEPTACLE

For automatic machine

 UL Recognized

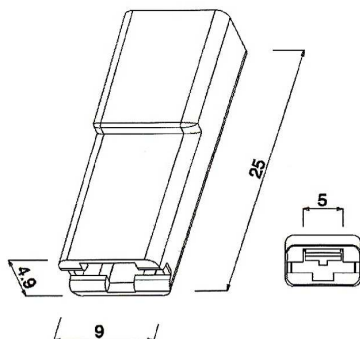

6,3 x 0,8



6,3 x 0,8

CODICE Code	CONFEZIONE Package	COLORE Colour	MATERIALE Material	INFIAMMABILITA' Flammability	
CT2002B	20.000	Neutro / Neutral	Nylon 66	UL94-V2	--
CT2002B1	20.000	Nero / Black	Nylon 66	UL94-V2	--
CT2002B2	20.000	Rosso / Red	Nylon 66	UL94-V2	--
CT2002B3	20.000	Verde / Green	Nylon 66	UL94-V2	--
CT2002B4	20.000	Giallo / Yellow	Nylon 66	UL94-V2	--
CT2002B5	20.000	Blu / Blue	Nylon 66	UL94-V2	--
CT2002BH	20.000	Neutro / Neutral	Nylon 66	UL94-V2	GWT NoFlame
CT2002BH1	20.000	Nero / Black	Nylon 66	UL94-V2	GWT NoFlame
CT2002BH2	20.000	Rosso / Red	Nylon 66	UL94-V2	GWT NoFlame
CT2002BH3	20.000	Verde / Green	Nylon 66	UL94-V2	GWT NoFlame
CT2002BH4	20.000	Giallo / Yellow	Nylon 66	UL94-V2	GWT NoFlame
CT2002BH5	20.000	Blu / Blue	Nylon 66	UL94-V2	GWT NoFlame
CT2002BV0	20.000	Neutro / Neutral	Nylon 66	UL94-V0	RTI 110
CT2002BZ	20.000	Neutro / Neutral	Nylon 66	UL94-V0	GWT NoFlame
CT2002BZ1	20.000	Nero / Black	Nylon 66	UL94-V0	GWT NoFlame
CT2002BZ2	20.000	Rosso / Red	Nylon 66	UL94-V0	GWT NoFlame
CT2002BV	20.000	Neutro / Neutral	Nylon 46	UL94-V2	RTI120 / RTI-EI 150

SERIE 6,3mm TERMINALI e CONNETTORI .250" TERMINALS and CONNECTORS

COPRIFASTON PER TERMINALE FEMMINA

Per inseritrice automatica – Tipo Fiat

CONNECTOR FOR QUICK-CONNECT RECEPTACLE

For automatic machine – Fiat shape

 UL Recognized

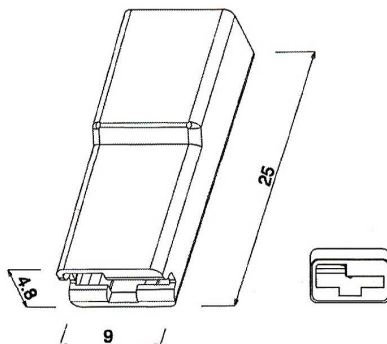

6,3 x 0,8



6,3 x 0,8

CODICE Code	CONFEZIONE Package	COLORE Colour	MATERIALE Material	INFIAMMABILITA' Flammability	
CT2002F	20.000	Neutro / Neutral	Nylon 66	UL94-V2	--
CT2002F1	20.000	Nero / Black	Nylon 66	UL94-V2	--
CT2002F2	20.000	Rosso / Red	Nylon 66	UL94-V2	--
CT2002F3	20.000	Verde / Green	Nylon 66	UL94-V2	--
CT2002F4	20.000	Giallo / Yellow	Nylon 66	UL94-V2	--
CT2002F5	20.000	Blu / Blue	Nylon 66	UL94-V2	--
CT2002FH	20.000	Neutro / Neutral	Nylon 66	UL94-V2	GWT NoFlame
CT2002FH1	20.000	Nero / Black	Nylon 66	UL94-V2	GWT NoFlame
CT2002FH2	20.000	Rosso / Red	Nylon 66	UL94-V2	GWT NoFlame
CT2002FH3	20.000	Verde / Green	Nylon 66	UL94-V2	GWT NoFlame
CT2002FH4	20.000	Giallo / Yellow	Nylon 66	UL94-V2	GWT NoFlame
CT2002FH5	20.000	Blu / Blue	Nylon 66	UL94-V2	GWT NoFlame
CT2002FV0	20.000	Neutro / Neutral	Nylon 66	UL94-V0	RTI 110
CT2002FZ	20.000	Neutro / Neutral	Nylon 66	UL94-V0	GWT NoFlame
CT2002FZ1	20.000	Nero / Black	Nylon 66	UL94-V0	GWT NoFlame
CT2002FZ2	20.000	Rosso / Red	Nylon 66	UL94-V0	GWT NoFlame
CT2002FV	20.000	Neutro / Neutral	Nylon 46	UL94-V2	RTI120 / RTI-EI 150

SERIE 6,3mm TERMINALI e CONNETTORI .250" TERMINALS and CONNECTORS

COPRIFASTON PER TERMINALE FEMMINA

Compatibile al terminale di sicurezza – Tipo Ibrido

CONNECTOR FOR QUICK-CONNECT RECEPTACLE

Mating Self locking Receptacle – Hybrid shape

 UL Recognized

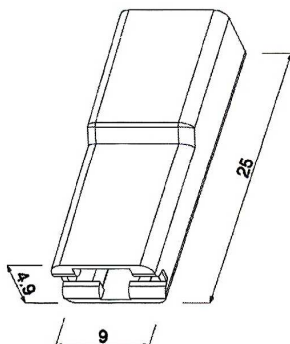

6,3 x 0,8



6,3 x 0,8



6,3 x 0,8

CODICE Code	CONFEZIONE Package	COLORE Colour	MATERIALE Material	INFIAMMABILITA' Flammability	
CT2002S	20.000	Neutro / Neutral	Nylon 66	UL94-V2	--
CT2002S1	20.000	Nero / Black	Nylon 66	UL94-V2	--
CT2002S2	20.000	Rosso / Red	Nylon 66	UL94-V2	--
CT2002S3	20.000	Verde / Green	Nylon 66	UL94-V2	--
CT2002S4	20.000	Giallo / Yellow	Nylon 66	UL94-V2	--
CT2002S5	20.000	Blu / Blue	Nylon 66	UL94-V2	--
CT2002SH	20.000	Neutro / Neutral	Nylon 66	UL94-V2	GWT NoFlame
CT2002SH1	20.000	Nero / Black	Nylon 66	UL94-V2	GWT NoFlame
CT2002SH2	20.000	Rosso / Red	Nylon 66	UL94-V2	GWT NoFlame
CT2002SH3	20.000	Verde / Green	Nylon 66	UL94-V2	GWT NoFlame
CT2002SH4	20.000	Giallo / Yellow	Nylon 66	UL94-V2	GWT NoFlame
CT2002SH5	20.000	Blu / Blue	Nylon 66	UL94-V2	GWT NoFlame
CT2002SV0	20.000	Neutro / Neutral	Nylon 66	UL94-V0	RTI 110
CT2002SZ	20.000	Neutro / Neutral	Nylon 66	UL94-V0	GWT NoFlame
CT2002SZ1	20.000	Nero / Black	Nylon 66	UL94-V0	GWT NoFlame
CT2002SZ2	20.000	Rosso / Red	Nylon 66	UL94-V0	GWT NoFlame
CT2002SV	20.000	Neutro / Neutral	Nylon 46	UL94-V2	RTI120 / RTI-EI 150

SERIE 6,3mm TERMINALI e CONNETTORI .250" TERMINALS and CONNECTORS

TERMINALE FEMMINA 6,3x0,8 - ANTISFILAMENTO
QUICK-CONNECT RECEPTACLE 6,3X0,8 - SELF LOCKING

 **UL Recognized**

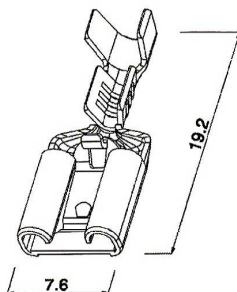

CODICE Code	SEZIONE CAVO Wire size		MATERIALE Material	TRATTAMENTO Treatment	CONFEZIONE Package	SPESSORE Thickness
	mm ²	AWG				
AS638241	0,5-1	20-17	Ottone / Brass	---	14.000	0,4
AS638243	0,5-1	20-17	Ottone / Brass	Pre stagnato/Pre-tinned	14.000	0,4
AS638244	0,5-1	20-17	Alpacca/Alpaka	---	14.000	0,4
AS638541	1-2,5	17-13	Ottone / Brass	---	13.000	0,4
AS638543	1-2,5	17-13	Ottone / Brass	Pre stagnato/Pre-tinned	13.000	0,4
AS638544	1-2,5	17-13	Alpacca/Alpaka	---	13.000	0,4

SERIE 6,3mm TERMINALI e CONNETTORI .250" TERMINALS and CONNECTORS

COPRIFASTON PER TERMINALE FEMMINA di sicurezza
CONNECTOR FOR SELF LOCKING RECEPTACLE

 **UL Recognized**

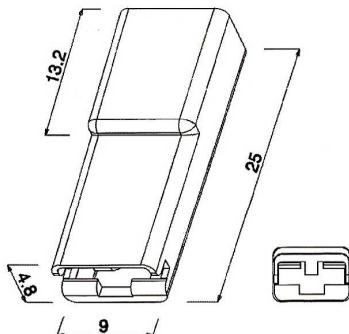

6,3 X 0,8

CODICE Code	CONFEZIONE Package	COLORE Colour	MATERIALE Material	INFIAMMABILITA' Flammability	
CT2003	20.000	Neutro / Neutral	Nylon 66	UL94-V2	--
CT2003-1	20.000	Nero / Black	Nylon 66	UL94-V2	--
CT2003-2	20.000	Rosso / Red	Nylon 66	UL94-V2	--
CT2003-3	20.000	Verde / Green	Nylon 66	UL94-V2	--
CT2003-4	20.000	Giallo / Yellow	Nylon 66	UL94-V2	--
CT2003-5	20.000	Blu / Blue	Nylon 66	UL94-V2	--
CT2003H	20.000	Neutro / Neutral	Nylon 66	UL94-V2	GWT NoFlame
CT2003H1	20.000	Nero / Black	Nylon 66	UL94-V2	GWT NoFlame
CT2003H2	20.000	Rosso / Red	Nylon 66	UL94-V2	GWT NoFlame
CT2003H3	20.000	Verde / Green	Nylon 66	UL94-V2	GWT NoFlame
CT2003H4	20.000	Giallo / Yellow	Nylon 66	UL94-V2	GWT NoFlame
CT2003H5	20.000	Blu / Blue	Nylon 66	UL94-V2	GWT NoFlame
CT2003V0	20.000	Neutro / Neutral	Nylon 66	UL94-V0	RTI 110
CT2003Z	20.000	Neutro / Neutral	Nylon 66	UL94-V0	GWT NoFlame
CT2003Z1	20.000	Nero / Black	Nylon 66	UL94-V0	GWT NoFlame
CT2003Z2	20.000	Rosso / Red	Nylon 66	UL94-V0	GWT NoFlame
CT2003V	20.000	Neutro / Neutral	Nylon 46	UL94-V2	RTI120 / RTI-EI 150

SERIE 6,3mm TERMINALI e CONNETTORI

.250" TERMINALS and CONNECTORS

COPRIFASTON PER TERMINALE FEMMINA di sicurezza

Per inseritrice automatica

CONNECTOR FOR SELF LOCKING RECEPTACLE

For automatic machine

 UL Recognized

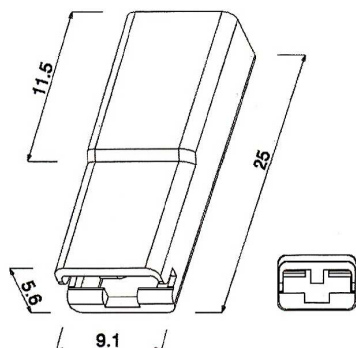

6,3 X 0,8

CODICE Code	CONFEZIONE Package	COLORE Colour	MATERIALE Material	INFIAMMABILITA' Flammability	
CT2003.S	20.000	Neutro / Neutral	Nylon 66	UL94-V2	--
CT2003.S1	20.000	Nero / Black	Nylon 66	UL94-V2	--
CT2003.S2	20.000	Rosso / Red	Nylon 66	UL94-V2	--
CT2003.S3	20.000	Verde / Green	Nylon 66	UL94-V2	--
CT2003.S4	20.000	Giallo / Yellow	Nylon 66	UL94-V2	--
CT2003.S5	20.000	Blu / Blue	Nylon 66	UL94-V2	--
CT2003H.S	20.000	Neutro / Neutral	Nylon 66	UL94-V2	GWT NoFlame
CT2003H.S1	20.000	Nero / Black	Nylon 66	UL94-V2	GWT NoFlame
CT2003H.S2	20.000	Rosso / Red	Nylon 66	UL94-V2	GWT NoFlame
CT2003H.S3	20.000	Verde / Green	Nylon 66	UL94-V2	GWT NoFlame
CT2003H.S4	20.000	Giallo / Yellow	Nylon 66	UL94-V2	GWT NoFlame
CT2003H.S5	20.000	Blu / Blue	Nylon 66	UL94-V2	GWT NoFlame
CT2003V0.S	20.000	Neutro / Neutral	Nylon 66	UL94-V0	RTI 110
CT2003Z.S	20.000	Neutro / Neutral	Nylon 66	UL94-V0	GWT NoFlame
CT2003Z.S1	20.000	Nero / Black	Nylon 66	UL94-V0	GWT NoFlame
CT2003Z.S2	20.000	Rosso / Red	Nylon 66	UL94-V0	GWT NoFlame
CT2003V.S	20.000	Neutro / Neutral	Nylon 46	UL94-V2	RTI120 / RTI-EI 150

SERIE 6,3mm TERMINALI e CONNETTORI .250" TERMINALS and CONNECTORS

TERMINALE FEMMINA 6,3x0,8 – INSERIMENTO MORDIBO
QUICK-CONNECT RECEPTACLE 6,3X0,8 – LOW INS. FORCE

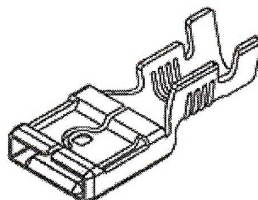

CODICE Code	SEZIONE CAVO Wire size		MATERIALE Material	TRATTAMENTO Treatment	CONFEZIONE Package	SPESSORE Thickness
	mm ²	AWG				
TE638241	0,5-1	20-17	Ottone / Brass	---	14.000	0,4
TE638242	0,5-1	20-17	Ottone / Brass	Pre stagnato/Pre-tinned	14.000	0,4
TE638541	1-2,5	17-13	Ottone / Brass	---	13.000	0,4
TE638542	1-2,5	17-13	Ottone / Brass	Pre stagnato/Pre-tinned	13.000	0,4

SERIE 6,3mm TERMINALI e CONNETTORI

.250" TERMINALS and CONNECTORS

COPRIFASTON PER TERMINALE FEMMINA di sicurezza
CONNECTOR FOR SELF LOCKING RECEPTACLE

 **UL Recognized**

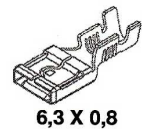
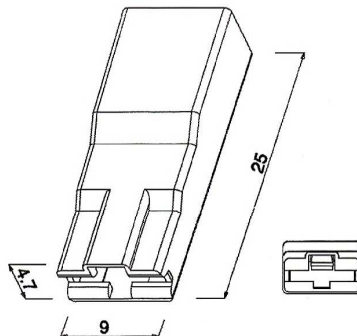

CODICE Code	CONFEZIONE Package	COLORE Colour	MATERIALE Material	INFIAMMABILITA' Flammability	
CT2002E	20.000	Neutro / Neutral	Nylon 66	UL94-V2	--
CT2002E1	20.000	Nero / Black	Nylon 66	UL94-V2	--
CT2002E2	20.000	Rosso / Red	Nylon 66	UL94-V2	--
CT2002E3	20.000	Verde / Green	Nylon 66	UL94-V2	--
CT2002E4	20.000	Giallo / Yellow	Nylon 66	UL94-V2	--
CT2002E5	20.000	Blu / Blue	Nylon 66	UL94-V2	--
CT2002EH	20.000	Neutro / Neutral	Nylon 66	UL94-V2	GWT NoFlame
CT2002EH1	20.000	Nero / Black	Nylon 66	UL94-V2	GWT NoFlame
CT2002EH2	20.000	Rosso / Red	Nylon 66	UL94-V2	GWT NoFlame
CT2002EH3	20.000	Verde / Green	Nylon 66	UL94-V2	GWT NoFlame
CT2002EH4	20.000	Giallo / Yellow	Nylon 66	UL94-V2	GWT NoFlame
CT2002EH5	20.000	Blu / Blue	Nylon 66	UL94-V2	GWT NoFlame
CT2002EV0	20.000	Neutro / Neutral	Nylon 66	UL94-V0	RTI 110
CT2002EZ	20.000	Neutro / Neutral	Nylon 66	UL94-V0	GWT NoFlame
CT2002EZ1	20.000	Nero / Black	Nylon 66	UL94-V0	GWT NoFlame
CT2002EZ2	20.000	Rosso / Red	Nylon 66	UL94-V0	GWT NoFlame
CT2002EV	20.000	Neutro / Neutral	Nylon 46	UL94-V2	RTI120 / RTI-EI 150

SERIE 6,3mm TERMINALI e CONNETTORI .250" TERMINALS and CONNECTORS

COPRIFASTON PER TERMINALE FEMMINA di sicurezza CONNECTOR FOR SELF LOCKING RECEPTACLE

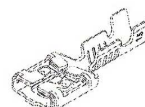
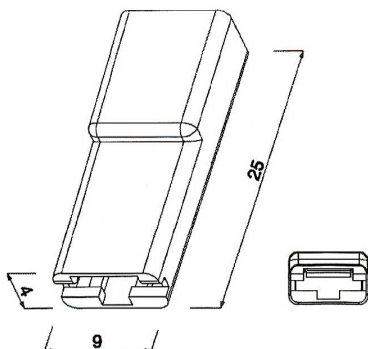

6,3 X 0,8

CODICE Code	CONFEZIONE Package	COLORE Colour	MATERIALE Material	INFIAMMABILITA' Flammability	
CT2004	20.000	Neutro / Neutral	Nylon 66	UL94-V2	--
CT2004-1	20.000	Nero / Black	Nylon 66	UL94-V2	--
CT2004-2	20.000	Rosso / Red	Nylon 66	UL94-V2	--
CT2004H	20.000	Neutro / Neutral	Nylon 66	UL94-V2	GWT NoFlame
CT2004H1	20.000	Nero / Black	Nylon 66	UL94-V2	GWT NoFlame
CT2004H2	20.000	Rosso / Red	Nylon 66	UL94-V2	GWT NoFlame
CT2004V0	20.000	Neutro / Neutral	Nylon 66	UL94-V0	RTI 110
CT2004Z	20.000	Neutro / Neutral	Nylon 66	UL94-V0	GWT NoFlame
CT2004Z1	20.000	Nero / Black	Nylon 66	UL94-V0	GWT NoFlame
CT2004Z2	20.000	Rosso / Red	Nylon 66	UL94-V0	GWT NoFlame
CT2004V	20.000	Neutro / Neutral	Nylon 46	UL94-V2	RTI120 / RTI-EI 150

SERIE 6,3mm TERMINALI e CONNETTORI .250" TERMINALS and CONNECTORS

TERMINALE FEMMINA 6,3x0,8 BANDIERA
QUICK-CONNECT RECEPTACLE 6,3X0,8 FLAG SHAPE

 UL Recognized - DIN 46346

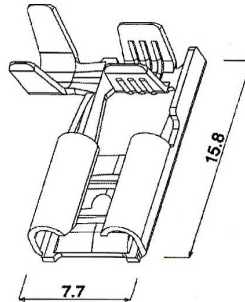

CODICE Code	SEZIONE CAVO Wire size		MATERIALE Material	TRATTAMENTO Treatment	CONFEZIONE Package	SPESSORE Thickness
	mm ²	AWG				
TB638241	0,5-1	20-17	Ottone / Brass	---	10.000	0,42
TB638242	0,5-1	20-17	Ottone / Brass	Stagnato / Tin plated	11.000	0,40
TB638245	0,5-1	20-17	Acciaio / Steel	Nichelato / Nickeled	11.000	0,42
TB638541	1-2,5	17-13	Ottone / Brass	---	10.000	0,42
TB638542	1-2,5	17-13	Ottone / Brass	Stagnato / Tin plated	10.000	0,40
TB638545	1-2,5	17-13	Acciaio / Steel	Nichelato / Nickeled	10.000	0,42

SERIE 6,3mm TERMINALI e CONNETTORI .250" TERMINALS and CONNECTORS

COPRIFASTON FEMMINA A BANDIERA CONNECTOR FOR QUICK-CONNECT FLAG RECEPTACLE

 UL Recognized

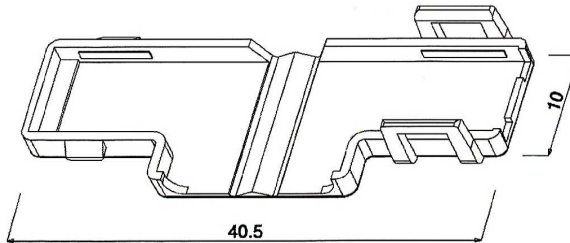

0,5-1,0 mm²
20-17 AWG

CODICE Code	CONFEZIONE Package	COLORE Colour	MATERIALE Material	INFIAMMABILITA' Flammability	
CT1005	10000	Neutro / Neutral	Nylon 66	UL94-V2	--
CT1005-1	10000	Nero / Black	Nylon 66	UL94-V2	--
CT1005-2	10000	Rosso / Red	Nylon 66	UL94-V2	--
CT1005H	10000	Neutro / Neutral	Nylon 66	UL94-V2	GWT NoFlame
CT1005V0	10000	Neutro / Neutral	Nylon 66	UL94-V0	RTI 110
CT1005Z	10000	Neutro / Neutral	Nylon 66	UL94-V0	GWT NoFlame

COPRIFASTON FEMMINA A BANDIERA CONNECTOR FOR QUICK-CONNECT FLAG RECEPTACLE

 UL Recognized

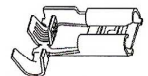
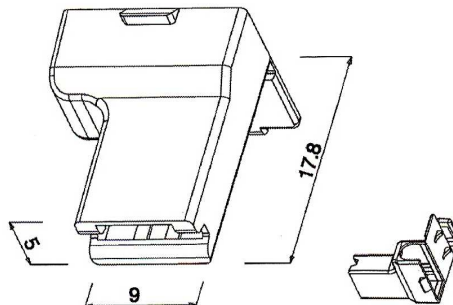

1-2.5 mm²
17-13 AWG

CODICE Code	CONFEZIONE Package	COLORE Colour	MATERIALE Material	INFIAMMABILITA' Flammability	
CT1007B	10000	Neutro / Neutral	Nylon 66	UL94-V2	--
CT1007B1	10000	Nero / Black	Nylon 66	UL94-V2	--
CT1007B2	10000	Rosso / Red	Nylon 66	UL94-V2	--
CT1007BH	10000	Neutro / Neutral	Nylon 66	UL94-V2	GWT NoFlame
CT1007BV0	10000	Neutro / Neutral	Nylon 66	UL94-V0	RTI 110
CT1007BZ	10000	Neutro / Neutral	Nylon 66	UL94-V0	GWT NoFlame

SERIE 6,3mm TERMINALI e CONNETTORI .250" TERMINALS and CONNECTORS

COPRIFASTON FEMMINA A BANDIERA CONNECTOR FOR QUICK-CONNECT FLAG RECEPTACLE

 UL Recognized

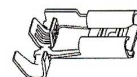
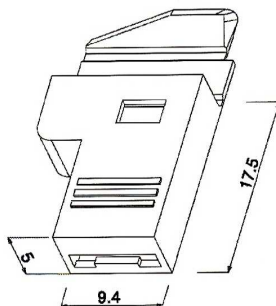

0,5-1,0 mm²
20-17 AWG

CODICE Code	CONFEZIONE Package	COLORE Colour	MATERIALE Material	INFIAMMABILITA' Flammability	
CT1006A	10000	Neutro / Neutral	Nylon 66	UL94-V2	--
CT1006A1	10000	Nero / Black	Nylon 66	UL94-V2	--
CT1006A2	10000	Rosso / Red	Nylon 66	UL94-V2	--
CT1006AH	10000	Neutro / Neutral	Nylon 66	UL94-V2	GWT NoFlame
CT1006AV0	10000	Neutro / Neutral	Nylon 66	UL94-V0	RTI 110
CT1006AZ	10000	Neutro / Neutral	Nylon 66	UL94-V0	GWT NoFlame

COPRIFASTON FEMMINA A BANDIERA CONNECTOR FOR QUICK-CONNECT FLAG RECEPTACLE

 UL Recognized

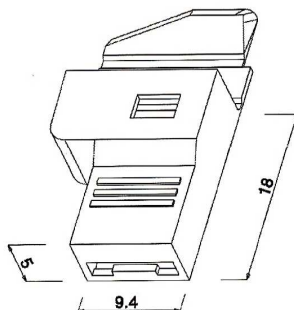

1-2.5 mm²
17-13 AWG

CODICE Code	CONFEZIONE Package	COLORE Colour	MATERIALE Material	INFIAMMABILITA' Flammability	
CT1006B	10000	Neutro / Neutral	Nylon 66	UL94-V2	--
CT1006B1	10000	Nero / Black	Nylon 66	UL94-V2	--
CT1006B2	10000	Rosso / Red	Nylon 66	UL94-V2	--
CT1006BH	10000	Neutro / Neutral	Nylon 66	UL94-V2	GWT NoFlame
CT1006BV0	10000	Neutro / Neutral	Nylon 66	UL94-V0	RTI 110
CT1006BZ	10000	Neutro / Neutral	Nylon 66	UL94-V0	GWT NoFlame

SERIE 6,3mm TERMINALI e CONNETTORI .250" TERMINALS and CONNECTORS

TERMINALE FEMMINA 6,3x0,8 ROLLATO

QUICK-CONNECT RECEPTACLE 6,3x0,8 ShortFlagShape

 UL Recognized - DIN 46247 F.3

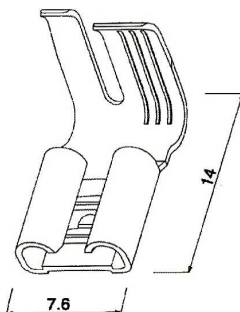

CODICE Code	SEZIONE CAVO Wire size		MATERIALE Material	TRATTAMENTO Treatment	CONFEZIONE Package	SPESSORE Thickness
	mm ²	AWG				
TR638441	0,5-1,8	20-14	Ottone / Brass	---	6.000	0,42
TR638442	0,5-1,8	20-14	Ottone / Brass	Stagnato / Tin plated	5.000	0,40
TR638445	0,5-1,8	20-14	Acciaio / Steel	Nichelato / Nickerled	5.000	0,40
TR638541	1,5-3	15-12	Ottone / Brass	---	6.000	0,42
TR638542	1,5-3	15-12	Ottone / Brass	Stagnato / Tin plated	4.000	0,40
TR638545	1,5-3	15-12	Acciaio / Steel	Nichelato / Nickerled	4.000	0,40

SERIE 6,3mm TERMINALI e CONNETTORI

.250" TERMINALS and CONNECTORS

COPRIFASTON FEMMINA A BANDIERA ROLLATO

CONNECTOR FOR QUICK-CONNECT SHORT FLAG RECEPTACLE

 UL Recognized

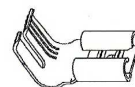
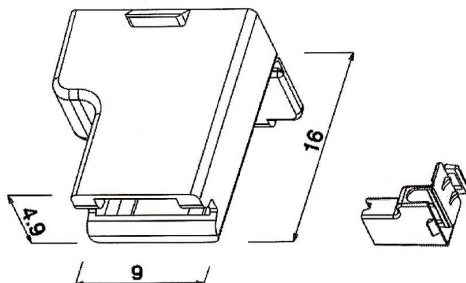

0,5-1,8 mm²
20-14 AWG

CODICE Code	CONFEZIONE Package	COLORE Colour	MATERIALE Material	INFIAMMABILITA' Flammability	
CT1007C	10000	Neutro / Neutral	Nylon 66	UL94-V2	--
CT1007C1	10000	Nero / Black	Nylon 66	UL94-V2	--
CT1007C2	10000	Rosso / Red	Nylon 66	UL94-V2	--
CT1007CH	10000	Neutro / Neutral	Nylon 66	UL94-V2	GWT NoFlame
CT1007CV0	10000	Neutro / Neutral	Nylon 66	UL94-V0	RTI 110
CT1007CZ	10000	Neutro / Neutral	Nylon 66	UL94-V0	GWT NoFlame

COPRIFASTON FEMMINA A BANDIERA ROLLATO

CONNECTOR FOR QUICK-CONNECT SHORT FLAG RECEPTACLE

 UL Recognized

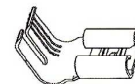
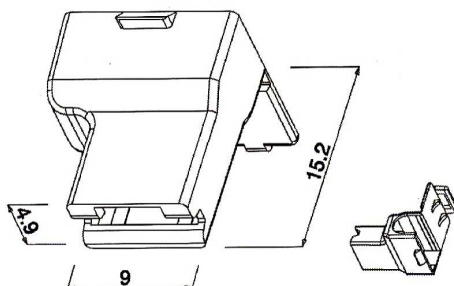

1,5-3 mm²
15-12 AWG

CODICE Code	CONFEZIONE Package	COLORE Colour	MATERIALE Material	INFIAMMABILITA' Flammability	
CT1007D	10000	Neutro / Neutral	Nylon 66	UL94-V2	--
CT1007D1	10000	Nero / Black	Nylon 66	UL94-V2	--
CT1007D2	10000	Rosso / Red	Nylon 66	UL94-V2	--
CT1007DH	10000	Neutro / Neutral	Nylon 66	UL94-V2	GWT NoFlame
CT1007DV0	10000	Neutro / Neutral	Nylon 66	UL94-V0	RTI 110
CT1007DZ	10000	Neutro / Neutral	Nylon 66	UL94-V0	GWT NoFlame

SERIE 6,3mm TERMINALI e CONNETTORI .250" TERMINALS and CONNECTORS

COPRIFASTON FEMMINA A BANDIERA ROLLATO CONNECTOR FOR QUICK-CONNECT SHORT FLAG RECEPTACLE

 UL Recognized

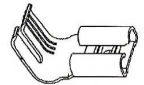
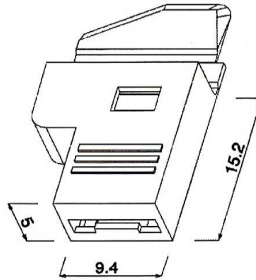

0,5-1.0 mm²
20-17 AWG

CODICE Code	CONFEZIONE Package	COLORE Colour	MATERIALE Material	INFIAMMABILITA' Flammability	
CT1006C	10000	Neutro / Neutral	Nylon 66	UL94-V2	--
CT1006C1	10000	Nero / Black	Nylon 66	UL94-V2	--
CT1006C2	10000	Rosso / Red	Nylon 66	UL94-V2	--
CT1006CH	10000	Neutro / Neutral	Nylon 66	UL94-V2	GWT NoFlame
CT1006CV0	10000	Neutro / Neutral	Nylon 66	UL94-V0	RTI 110
CT1006CZ	10000	Neutro / Neutral	Nylon 66	UL94-V0	GWT NoFlame

COPRIFASTON FEMMINA A BANDIERA ROLLATO CONNECTOR FOR QUICK-CONNECT SHORT FLAG RECEPTACLE

 UL Recognized

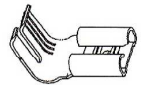
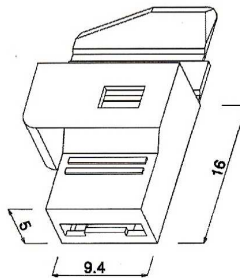

0,5-1.0 mm²
20-17 AWG

CODICE Code	CONFEZIONE Package	COLORE Colour	MATERIALE Material	INFIAMMABILITA' Flammability	
CT1006D	10000	Neutro / Neutral	Nylon 66	UL94-V2	--
CT1006D1	10000	Nero / Black	Nylon 66	UL94-V2	--
CT1006D2	10000	Rosso / Red	Nylon 66	UL94-V2	--
CT1006DH	10000	Neutro / Neutral	Nylon 66	UL94-V2	GWT NoFlame
CT1006DV0	10000	Neutro / Neutral	Nylon 66	UL94-V0	RTI 110
CT1006DZ	10000	Neutro / Neutral	Nylon 66	UL94-V0	GWT NoFlame

SERIE 6,3mm TERMINALI e CONNETTORI .250" TERMINALS and CONNECTORS

**TERMINALE FEMMINA 6,3x0,8 BANDIERA
AGGRAFF. MISTA e INSERIMENTO MORBIDO**
QUICK-CONNECT RECEPTACLE 6,3X0,8
FLAG MIXED SEAMING and LOW INSERTION FORCE

 UL Recognized

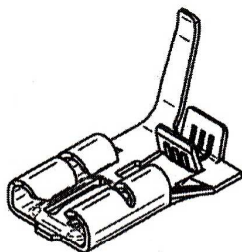

CODICE Code	SEZIONE CAVO Wire size		MATERIALE Material	TRATTAMENTO Treatment	CONFEZIONE Package	SPESSORE Thickness
	mm ²	AWG				
IMR68441	0,5-1,5	20-15	Ottone / Brass	---	5.600	0,40
IMR68443	0,5-1,5	20-15	Ottone / Brass	Prestagnato /Pre tinned	5.600	0,40
IMR68444	0,5-1,5	20-15	Alpacca/Alpaka	---	5.600	0,40
IMR68445	0,5-1,5	20-15	Acciaio / Steel	Nichelato / Pre nickeled	5.000	0,40
IMR68541	1,5-2,5	15-13	Ottone / Brass	---	4.600	0,40
IMR68543	1,5-2,5	15-13	Ottone / Brass	Prestagnato /Pre tinned	4.600	0,40
IMR68544	1,5-2,5	15-13	Alpacca/Alpaka	---	4.600	0,40
IMR68441	0,5-1,5	20-15	Ottone / Brass	---	5.600	0,40
IMR68545	1,5-2,5	15-13	Acciaio / Steel	Nichelato / Pre nickeled	4.500	0,40

COPRIFASTON FEMMINA A BANDIERA ROLLATO
CONNECTOR FOR QUICK-CONNECT SHORT FLAG RECEPTACLE

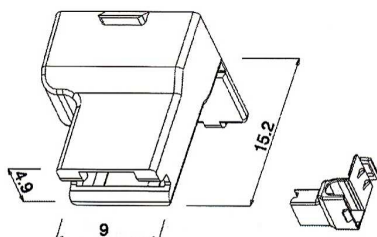

CT1007D - vedi pagina 72
CT1007D - see page 72

SERIE 6,3mm TERMINALI e CONNETTORI .250" TERMINALS and CONNECTORS

TERMINALE FEMMINA CON DENTINO QUICK-CONNECT RECEPTACLE WITH CHECK TOOTH

 UL Recognized - DIN 46340 F.3

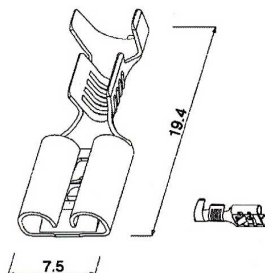

* con bugna

CODICE Code	SEZIONE CAVO Wire size		MATERIALE Material	TRATTAMENTO Treatment	CONFEZIONE Package	SPESSORE Thickness
	mm ²	AWG				
FF638221	0,5-1	20-17	Ottone / Brass	---	10.000	0,32
FF638222	0,5-1	20-17	Ottone / Brass	Stagnato / Tin plated	14.000	0,32
FFD68221*	0,5-1	20-17	Ottone / Brass	---	10.000	0,32
FF638521	0,75-2,5	18-13	Ottone / Brass	---	10.000	0,32
FF638522	0,75-2,5	18-13	Ottone / Brass	Stagnato / Tin plated	13.000	0,32
FFD68521*	0,75-2,5	18-13	Ottone / Brass	Stagnato / Tin plated	10.000	0,32

TERMINALE MASCHIO CON DENTINO QUICK-CONNECT TAB WITH CHECK TOOTH

 UL Recognized - DIN 46343 F.3

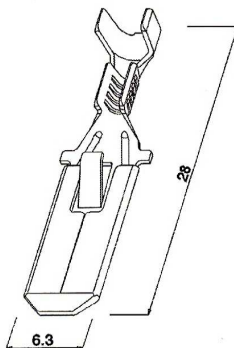

* Versione con foro su richiesta
Version with hole on request

CODICE Code	SEZIONE CAVO Wire size		MATERIALE Material	TRATTAMENTO Treatment	CONFEZIONE Package	SPESSORE Thickness
	mm ²	AWG				
FM638231	0,5-1	20-17	Ottone / Brass	---	10.000	0,40
FM638233	0,5-1	20-17	Ottone / Brass	Stagnato / Tin plated	12.000	0,40
FM638531	0,75-2,5	18-13	Ottone / Brass	---	10.000	0,40
FM638533	0,75-2,5	18-13	Ottone / Brass	Stagnato / Tin plated	12.000	0,40

SERIE 6,3mm TERMINALI e CONNETTORI .250" TERMINALS and CONNECTORS

CONNETTORE 1 VIA PER TERMINALE FEMMINA 1 WAY HOUSING FOR RECEPTACLE

 UL Recognized

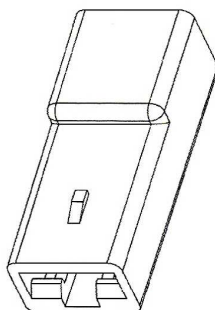

6,3 x 0,8

CODICE Code	CONFEZIONE Package	COLORE Colour	MATERIALE Material	INFIAMMABILITA' Flammability	
CT1010	10.000	Neutro / Neutral	Nylon 66	UL94-V2	--
CT1010-1	10.000	Nero / Black	Nylon 66	UL94-V2	--
CT1010-2	10.000	Rosso / Red	Nylon 66	UL94-V2	--
CT1010H	10.000	Neutro / Neutral	Nylon 66	UL94-V2	GWT NoFlame
CT1010V0	10.000	Neutro / Neutral	Nylon 66	UL94-V0	RTI 110
CT1010Z	10.000	Neutro / Neutral	Nylon 66	UL94-V0	GWT NoFlame
CT1010V	10.000	Neutro / Neutral	Nylon 66	UL94-V2	RTI120 - RTI Elec150

CONNETTORE 1 VIA PER TERMINALE FEMMINA – TIPO FIAT 1 WAY HOUSING FOR RECEPTACLE – FIAT SHAPE

 UL Recognized

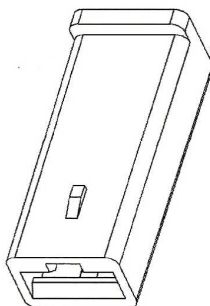

6,3 x 0,8

CODICE Code	CONFEZIONE Package	COLORE Colour	MATERIALE Material	INFIAMMABILITA' Flammability	
CT1010F	10.000	Neutro / Neutral	Nylon 66	UL94-V2	--
CT1010F1	10.000	Nero / Black	Nylon 66	UL94-V2	--
CT1010F2	10.000	Rosso / Red	Nylon 66	UL94-V2	--
CT1010FH	10.000	Neutro / Neutral	Nylon 66	UL94-V2	GWT NoFlame
CT1010FV0	10.000	Neutro / Neutral	Nylon 66	UL94-V0	RTI 110
CT1010FZ	10.000	Neutro / Neutral	Nylon 66	UL94-V0	GWT NoFlame
CT1010FV	10.000	Neutro / Neutral	Nylon 46	UL94-V2	RTI120 / RTI-EI 150

SERIE 6,3mm TERMINALI e CONNETTORI .250" TERMINALS and CONNECTORS

CONNETTORE 1 VIA PER TERMINALE MASCHIO 1 WAY HOUSING FOR TAB

 UL Recognized

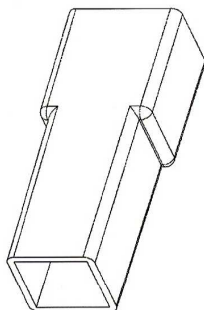

6,3 x 0,8

CODICE Code	CONFEZIONE Package	COLORE Colour	MATERIALE Material	INFIAMMABILITA' Flammability	
CT1011	5000	Neutro / Neutral	Nylon 66	UL94-V2	--
CT1011-1	5000	Nero / Black	Nylon 66	UL94-V2	--
CT1011-2	5000	Rosso / Red	Nylon 66	UL94-V2	--
CT1011H	5000	Neutro / Neutral	Nylon 66	UL94-V2	GWT NoFlame
CT1011V0	5000	Neutro / Neutral	Nylon 66	UL94-V0	RTI 110
CT1011Z	5000	Neutro / Neutral	Nylon 66	UL94-V0	GWT NoFlame
CT1011V	5000	Neutro / Neutral	Nylon 66	UL94-V2	RTI120 - RTI Elec150

SERIE 6,3mm TERMINALI e CONNETTORI .250" TERMINALS and CONNECTORS

CONNETTORE 2 VIE PER TERMINALE FEMMINA 2 WAYS HOUSING FOR RECEPTACLE

 UL Recognized

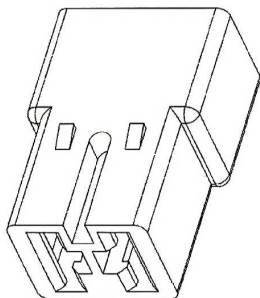

6,3 x 0,8

CODICE Code	CONFEZIONE Package	COLORE Colour	MATERIALE Material	INFIAMMABILITA' Flammability	
CT1020	5000	Neutro / Neutral	Nylon 66	UL94-V2	--
CT1020-1	5000	Nero / Black	Nylon 66	UL94-V2	--
CT1020-2	5000	Rosso / Red	Nylon 66	UL94-V2	--
CT1020H	5000	Neutro / Neutral	Nylon 66	UL94-V2	GWT NoFlame
CT1020V0	5000	Neutro / Neutral	Nylon 66	UL94-V0	RTI 110
CT1020Z	5000	Neutro / Neutral	Nylon 66	UL94-V0	GWT NoFlame
CT1020V	5000	Neutro / Neutral	Nylon 66	UL94-V2	RTI120 - RTI Elec150

CONNETTORE 2 VIE PER TERMINALE MASCHIO 2 WAYS HOUSING FOR TAB

 UL Recognized

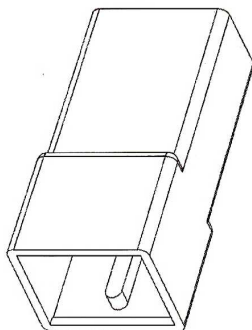

6,3 x 0,8

CODICE Code	CONFEZIONE Package	COLORE Colour	MATERIALE Material	INFIAMMABILITA' Flammability	
CT1021	5000	Neutro / Neutral	Nylon 66	UL94-V2	--
CT1021-1	5000	Nero / Black	Nylon 66	UL94-V2	--
CT1021-2	5000	Rosso / Red	Nylon 66	UL94-V2	--
CT1021H	5000	Neutro / Neutral	Nylon 66	UL94-V2	GWT NoFlame
CT1021V0	5000	Neutro / Neutral	Nylon 66	UL94-V0	RTI 110
CT1021Z	5000	Neutro / Neutral	Nylon 66	UL94-V0	GWT NoFlame
CT1021V	5000	Neutro / Neutral	Nylon 66	UL94-V2	RTI120 - RTI Elec150

SERIE 6,3mm TERMINALI e CONNETTORI .250" TERMINALS and CONNECTORS

CONNETTORE 2 VIE PER TERMINALE FEMMINA 2 WAYS HOUSING FOR RECEPTACLE

 UL Recognized

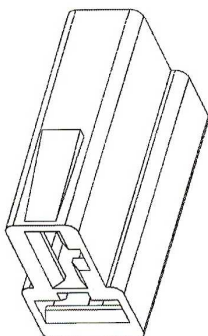

6,3 x 0,8

CODICE Code	CONFEZIONE Package	COLORE Colour	MATERIALE Material	INFIAMMABILITA' Flammability	
CT1022	5000	Neutro / Neutral	Nylon 66	UL94-V2	--
CT1022-1	5000	Nero / Black	Nylon 66	UL94-V2	--
CT1022-2	5000	Rosso / Red	Nylon 66	UL94-V2	--
CT1022H	5000	Neutro / Neutral	Nylon 66	UL94-V2	GWT NoFlame
CT1022V0	5000	Neutro / Neutral	Nylon 66	UL94-V0	RTI 110
CT1022Z	5000	Neutro / Neutral	Nylon 66	UL94-V0	GWT NoFlame
CT1022V	5000	Neutro / Neutral	Nylon 66	UL94-V2	RTI120 - RTI Elec150

CONNETTORE 2 VIE PER TERMINALE MASCHIO 2 WAYS HOUSING FOR TAB

 UL Recognized

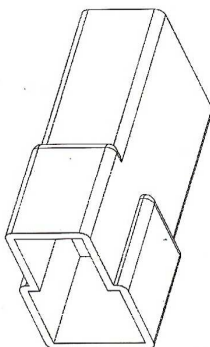

6,3 x 0,8

CODICE Code	CONFEZIONE Package	COLORE Colour	MATERIALE Material	INFIAMMABILITA' Flammability	
CT1023	5000	Neutro / Neutral	Nylon 66	UL94-V2	--
CT1023-1	5000	Nero / Black	Nylon 66	UL94-V2	--
CT1023-2	5000	Rosso / Red	Nylon 66	UL94-V2	--
CT1023H	5000	Neutro / Neutral	Nylon 66	UL94-V2	GWT NoFlame
CT1023V0	5000	Neutro / Neutral	Nylon 66	UL94-V0	RTI 110
CT1023Z	5000	Neutro / Neutral	Nylon 66	UL94-V0	GWT NoFlame
CT1023V	5000	Neutro / Neutral	Nylon 66	UL94-V2	RTI120 - RTI Elec150

SERIE 6,3mm TERMINALI e CONNETTORI .250" TERMINALS and CONNECTORS

CONNETTORE 2 VIE PER TERMINALE FEMMINA 2 WAYS HOUSING FOR RECEPTACLE

 UL Recognized

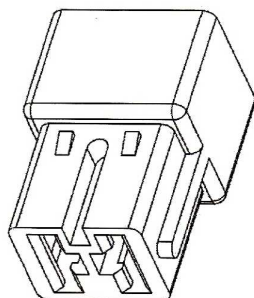

6,3 x 0,8

CODICE Code	CONFEZIONE Package	COLORE Colour	MATERIALE Material	INFIAMMABILITA' Flammability	
CT1024	5000	Neutro / Neutral	Nylon 66	UL94-V2	--
CT1024-1	5000	Nero / Black	Nylon 66	UL94-V2	--
CT1024-2	5000	Rosso / Red	Nylon 66	UL94-V2	--
CT1024H	5000	Neutro / Neutral	Nylon 66	UL94-V2	GWT NoFlame
CT1024V0	5000	Neutro / Neutral	Nylon 66	UL94-V0	RTI 110
CT1024Z	5000	Neutro / Neutral	Nylon 66	UL94-V0	GWT NoFlame
CT1024V	5000	Neutro / Neutral	Nylon 66	UL94-V2	RTI120 - RTI Elec150

CONNETTORE 2 VIE PER TERMINALE MASCHIO 2 WAYS HOUSING FOR TAB

 UL Recognized

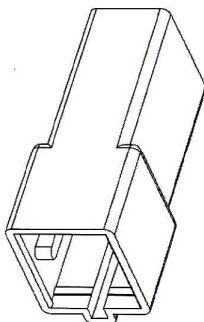

6,3 x 0,8

CODICE Code	CONFEZIONE Package	COLORE Colour	MATERIALE Material	INFIAMMABILITA' Flammability	
CT1025	5000	Neutro / Neutral	Nylon 66	UL94-V2	--
CT1025-1	5000	Nero / Black	Nylon 66	UL94-V2	--
CT1025-2	5000	Rosso / Red	Nylon 66	UL94-V2	--
CT1025H	5000	Neutro / Neutral	Nylon 66	UL94-V2	GWT NoFlame
CT1025V0	5000	Neutro / Neutral	Nylon 66	UL94-V0	RTI 110
CT1025Z	5000	Neutro / Neutral	Nylon 66	UL94-V0	GWT NoFlame
CT1025V	5000	Neutro / Neutral	Nylon 66	UL94-V2	RTI120 - RTI Elec150

SERIE 6,3mm TERMINALI e CONNETTORI .250" TERMINALS and CONNECTORS

CONNETTORE 2 VIE FEMMINA con ganci di sicurezza
FEMALE HOUSING 2 WAYS With secure lock

 UL Recognized

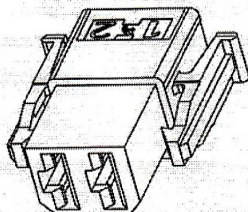

6,3 x 0,8

CODICE Code	CONFEZIONE Package	COLORE Colour	MATERIALE Material	INFIAMMABILITA' Flammability	
BS6002	5000	Neutro / Neutral	Nylon 66	UL94-V2	--
BS6002-1	5000	Nero / Black	Nylon 66	UL94-V2	--
BS6002-2	5000	Rosso / Red	Nylon 66	UL94-V2	--
BS6002H	5000	Neutro / Neutral	Nylon 66	UL94-V2	GWT NoFlame
BS6002V0	5000	Neutro / Neutral	Nylon 66	UL94-V0	RTI 110
BS6002Z	5000	Neutro / Neutral	Nylon 66	UL94-V0	GWT NoFlame
BS6002V	5000	Neutro / Neutral	Nylon 66	UL94-V2	RTI120 - RTI Elec150

CONNETTORE 2 VIE MASCHIO con ganci di sicurezza
MALE HOUSING 2 WAYS With secure lock

 UL Recognized

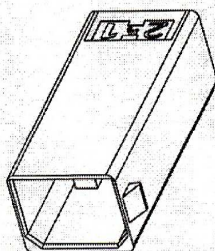

6,3 x 0,8

CODICE Code	CONFEZIONE Package	COLORE Colour	MATERIALE Material	INFIAMMABILITA' Flammability	
BS6102	5000	Neutro / Neutral	Nylon 66	UL94-V2	--
BS6102-1	5000	Nero / Black	Nylon 66	UL94-V2	--
BS6102-2	5000	Rosso / Red	Nylon 66	UL94-V2	--
BS6102H	5000	Neutro / Neutral	Nylon 66	UL94-V2	GWT NoFlame
BS6102V0	5000	Neutro / Neutral	Nylon 66	UL94-V0	RTI 110
BS6102Z	5000	Neutro / Neutral	Nylon 66	UL94-V0	GWT NoFlame
BS6102V	5000	Neutro / Neutral	Nylon 66	UL94-V2	RTI120 - RTI Elec150

SERIE 6,3mm TERMINALI e CONNETTORI

.250" TERMINALS and CONNECTORS

CONNETTORE 3 VIE PER TERMINALE FEMMINA

3 WAYS HOUSING FOR RECEPTACLE

 UL Recognized

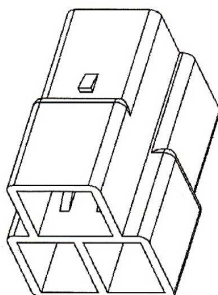

6,3 x 0,8

CODICE Code	CONFEZIONE Package	COLORE Colour	MATERIALE Material	INFIAMMABILITA' Flammability	
CT1030	2.500	Neutro / Neutral	Nylon 66	UL94-V2	--
CT1030-1	2.500	Nero / Black	Nylon 66	UL94-V2	--
CT1030-2	2.500	Rosso / Red	Nylon 66	UL94-V2	--
CT1030H	2.500	Neutro / Neutral	Nylon 66	UL94-V2	GWT NoFlame
CT1030V0	2.500	Neutro / Neutral	Nylon 66	UL94-V0	RTI 110
CT1030Z	2.500	Neutro / Neutral	Nylon 66	UL94-V0	GWT NoFlame
CT1030V	2.500	Neutro / Neutral	Nylon 66	UL94-V2	RTI120 - RTI Elec150

CONNETTORE 3 VIE PER TERMINALE MASCHIO

3 WAYS HOUSING FOR TAB

 UL Recognized

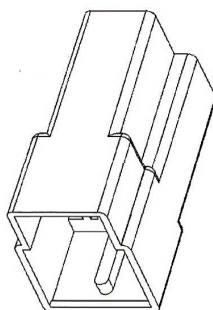

6,3 x 0,8

CODICE Code	CONFEZIONE Package	COLORE Colour	MATERIALE Material	INFIAMMABILITA' Flammability	
CT1031	2.500	Neutro / Neutral	Nylon 66	UL94-V2	--
CT1031-1	2.500	Nero / Black	Nylon 66	UL94-V2	--
CT1031-2	2.500	Rosso / Red	Nylon 66	UL94-V2	--
CT1031H	2.500	Neutro / Neutral	Nylon 66	UL94-V2	GWT.NoFlame
CT1031V0	2.500	Neutro / Neutral	Nylon 66	UL94-V0	RTI 110
CT1031Z	2.500	Neutro / Neutral	Nylon 66	UL94-V0	GWT.NoFlame
CT1031V	2.500	Neutro / Neutral	Nylon 66	UL94-V2	RTI120 - RTI Elec150

SERIE 6,3mm TERMINALI e CONNETTORI .250" TERMINALS and CONNECTORS

CONNETTORE 3 VIE PER TERMINALE FEMMINA 3 WAYS HOUSING FOR RECEPTACLE

 UL Recognized

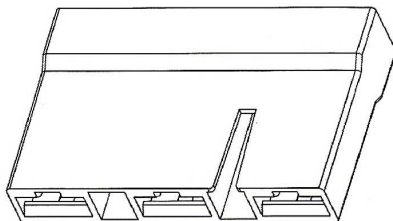

6,3 x 0,8

CODICE Code	CONFEZIONE Package	COLORE Colour	MATERIALE Material	INFIAMMABILITA' Flammability	
				UL94-V2	RTI
CT1034	2.500	Neutro / Neutral	Nylon 66	UL94-V2	--
CT1034-1	2.500	Nero / Black	Nylon 66	UL94-V2	--
CT1034-2	2.500	Rosso / Red	Nylon 66	UL94-V2	--
CT1034H	2.500	Neutro / Neutral	Nylon 66	UL94-V2	GWT NoFlame
CT1034V0	2.500	Neutro / Neutral	Nylon 66	UL94-V0	RTI 110
CT1034Z	2.500	Neutro / Neutral	Nylon 66	UL94-V0	GWT NoFlame
CT1034V	2.500	Neutro / Neutral	Nylon 66	UL94-V2	RTI120 - RTI Elec150

SERIE 6,3mm TERMINALI e CONNETTORI

.250" TERMINALS and CONNECTORS

CONNETTORE 4 VIE FEMMINA

FEMALE HOUSING 4 WAYS

 UL Recognized

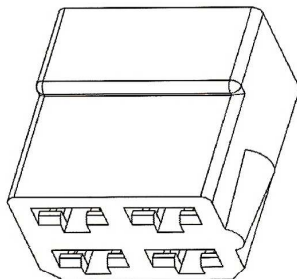

6,3 x 0,8

CODICE Code	CONFEZIONE Package	COLORE Colour	MATERIALE Material	INFIAMMABILITA' Flammability	
CT1040	2.500	Neutro / Neutral	Nylon 66	UL94-V2	--
CT1040-1	2.500	Nero / Black	Nylon 66	UL94-V2	--
CT1040-2	2.500	Rosso / Red	Nylon 66	UL94-V2	--
CT1040H	2.500	Neutro / Neutral	Nylon 66	UL94-V2	GWT NoFlame
CT1040V0	2.500	Neutro / Neutral	Nylon 66	UL94-V0	RTI 110
CT1040Z	2.500	Neutro / Neutral	Nylon 66	UL94-V0	GWT NoFlame
CT1040V	2.500	Neutro / Neutral	Nylon 66	UL94-V2	RTI120 - RTI Elec150

CONNETTORE 4 VIE MASCHIO

MALE HOUSING 4 WAYS

 UL Recognized

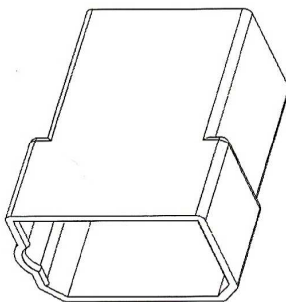

6,3 x 0,8

CODICE Code	CONFEZIONE Package	COLORE Colour	MATERIALE Material	INFIAMMABILITA' Flammability	
CT1041	2.500	Neutro / Neutral	Nylon 66	UL94-V2	--
CT1041-1	2.500	Nero / Black	Nylon 66	UL94-V2	--
CT1041-2	2.500	Rosso / Red	Nylon 66	UL94-V2	--
CT1041H	2.500	Neutro / Neutral	Nylon 66	UL94-V2	GWT NoFlame
CT1041V0	2.500	Neutro / Neutral	Nylon 66	UL94-V0	RTI 110
CT1041Z	2.500	Neutro / Neutral	Nylon 66	UL94-V0	GWT NoFlame
CT1041V	2.500	Neutro / Neutral	Nylon 66	UL94-V2	RTI120 - RTI Elec150

SERIE 6,3mm TERMINALI e CONNETTORI .250" TERMINALS and CONNECTORS

CONNETTORE 4 VIE MASCHIO CON GANCI PER PANNELLO MALE HOUSING 4 WAYS WITH PANEL MOUNTS

 UL Recognized

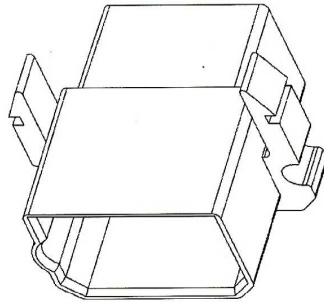

6,3 x 0,8

CODICE Code	CONFEZIONE Package	COLORE Colour	MATERIALE Material	INFIAMMABILITA' Flammability	
CT1043	1.250	Neutro / Neutral	Nylon 66	UL94-V2	--
CT1043-1	1.250	Nero / Black	Nylon 66	UL94-V2	--
CT1043-2	1.250	Rosso / Red	Nylon 66	UL94-V2	--
CT1043H	1.250	Neutro / Neutral	Nylon 66	UL94-V2	GWT NoFlame
CT1043V0	1.250	Neutro / Neutral	Nylon 66	UL94-V0	RTI 110
CT1043Z	1.250	Neutro / Neutral	Nylon 66	UL94-V0	GWT NoFlame
CT1043V	1.250	Neutro / Neutral	Nylon 66	UL94-V2	RTI120 - RTI Elec150

SERIE 6,3mm TERMINALI e CONNETTORI .250" TERMINALS and CONNECTORS

CONNETTORE 6 VIE FEMMINA FEMALE HOUSING 6 WAYS

 UL Recognized

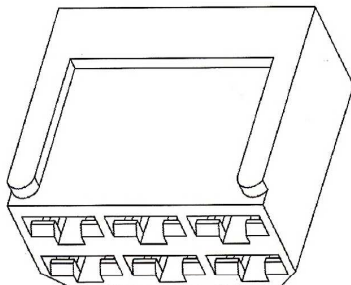

6,3 x 0,8

CODICE Code	CONFEZIONE Package	COLORE Colour	MATERIALE Material	INFIAMMABILITA' Flammability	
CT1060	1.000	Neutro / Neutral	Nylon 66	UL94-V2	--
CT1060-1	1.000	Nero / Black	Nylon 66	UL94-V2	--
CT1060-2	1.000	Rosso / Red	Nylon 66	UL94-V2	--
CT1060H	1.000	Neutro / Neutral	Nylon 66	UL94-V2	GWT NoFlame
CT1060V0	1.000	Neutro / Neutral	Nylon 66	UL94-V0	RTI 110
CT1060Z	1.000	Neutro / Neutral	Nylon 66	UL94-V0	GWT NoFlame
CT1060V	1.000	Neutro / Neutral	Nylon 66	UL94-V2	RTI120 - RTI Elec150

CONNETTORE 6 VIE MASCHIO CON GANCI PER PANNELLO MALE HOUSING 6 WAYS WITH PANEL MOUNTS

 UL Recognized

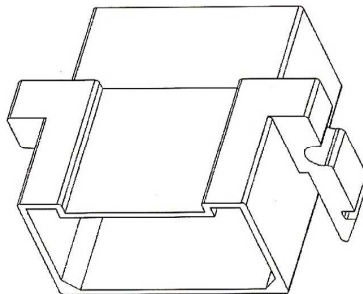

6,3 x 0,8

CODICE Code	CONFEZIONE Package	COLORE Colour	MATERIALE Material	INFIAMMABILITA' Flammability	
CT1061	1.000	Neutro / Neutral	Nylon 66	UL94-V2	--
CT1061-1	1.000	Nero / Black	Nylon 66	UL94-V2	--
CT1061-2	1.000	Rosso / Red	Nylon 66	UL94-V2	--
CT1061H	1.000	Neutro / Neutral	Nylon 66	UL94-V2	GWT NoFlame
CT1061V0	1.000	Neutro / Neutral	Nylon 66	UL94-V0	RTI 110
CT1061Z	1.000	Neutro / Neutral	Nylon 66	UL94-V0	GWT NoFlame
CT1061V	1.000	Neutro / Neutral	Nylon 66	UL94-V2	RTI120 - RTI Elec150

SERIE 6,3mm TERMINALI e CONNETTORI .250" TERMINALS and CONNECTORS

CONNETTORE 6 VIE FEMMINA CON GANCI PER PANNELLO FEMALE HOUSING 6 WAYS WITH PANEL MOUNTS

 UL Recognized

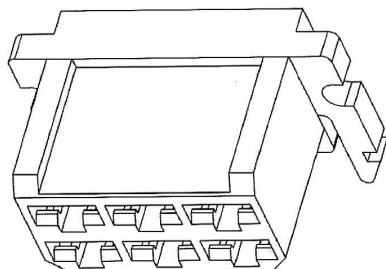

6,3 x 0,8

CODICE Code	CONFEZIONE Package	COLORE Colour	MATERIALE Material	INFIAMMABILITA' Flammability	
CT1062	1.000	Neutro / Neutral	Nylon 66	UL94-V2	--
CT1062-1	1.000	Nero / Black	Nylon 66	UL94-V2	--
CT1062-2	1.000	Rosso / Red	Nylon 66	UL94-V2	--
CT1062H	1.000	Neutro / Neutral	Nylon 66	UL94-V2	GWT NoFlame
CT1062V0	1.000	Neutro / Neutral	Nylon 66	UL94-V0	RTI 110
CT1062Z	1.000	Neutro / Neutral	Nylon 66	UL94-V0	GWT NoFlame
CT1062V	1.000	Neutro / Neutral	Nylon 66	UL94-V2	RTI120 - RTI Elec150

CONNETTORE 6 VIE MASCHIO MALE HOUSING 6 WAYS

 UL Recognized

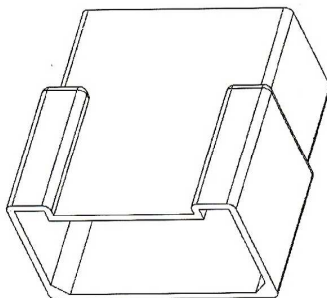

6,3 x 0,8

CODICE Code	CONFEZIONE Package	COLORE Colour	MATERIALE Material	INFIAMMABILITA' Flammability	
CT1063	1.000	Neutro / Neutral	Nylon 66	UL94-V2	--
CT1063-1	1.000	Nero / Black	Nylon 66	UL94-V2	--
CT1063-2	1.000	Rosso / Red	Nylon 66	UL94-V2	--
CT1063H	1.000	Neutro / Neutral	Nylon 66	UL94-V2	GWT NoFlame
CT1063V0	1.000	Neutro / Neutral	Nylon 66	UL94-V0	RTI 110
CT1063Z	1.000	Neutro / Neutral	Nylon 66	UL94-V0	GWT NoFlame
CT1063V	1.000	Neutro / Neutral	Nylon 66	UL94-V2	RTI120 - RTI Elec150

SERIE 6,3mm TERMINALI e CONNETTORI .250" TERMINALS and CONNECTORS

CONNETTORE 8 VIE FEMMINA FEMALE HOUSING 8 WAYS

 UL Recognized

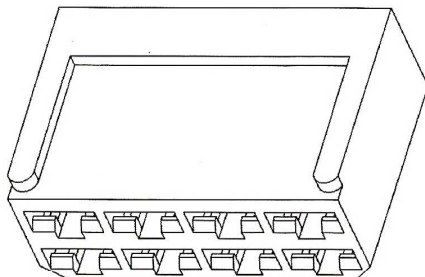

6,3 x 0,8

CODICE Code	CONFEZIONE Package	COLORE Colour	MATERIALE Material	INFIAMMABILITA' Flammability	
CT1080	1.000	Neutro / Neutral	Nylon 66	UL94-V2	--
CT1080-1	1.000	Nero / Black	Nylon 66	UL94-V2	--
CT1080-2	1.000	Rosso / Red	Nylon 66	UL94-V2	--
CT1080H	1.000	Neutro / Neutral	Nylon 66	UL94-V2	GWT NoFlame
CT1080V0	1.000	Neutro / Neutral	Nylon 66	UL94-V0	RTI 110
CT1080Z	1.000	Neutro / Neutral	Nylon 66	UL94-V0	GWT NoFlame
CT1080V	1.000	Neutro / Neutral	Nylon 66	UL94-V2	RTI120 - RTI Elec150

CONNETTORE 8 VIE MASCHIO CON GANCI PER PANNELLO MALE HOUSING 8 WAYS WITH PANEL MOUNTS

 UL Recognized

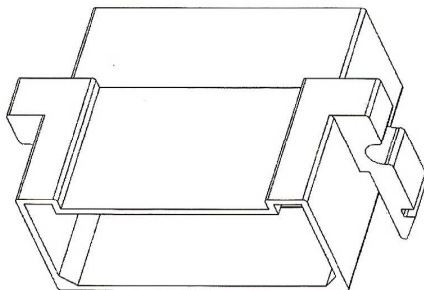

6,3 x 0,8

CODICE Code	CONFEZIONE Package	COLORE Colour	MATERIALE Material	INFIAMMABILITA' Flammability	
CT1081	1.000	Neutro / Neutral	Nylon 66	UL94-V2	--
CT1081-1	1.000	Nero / Black	Nylon 66	UL94-V2	--
CT1081-2	1.000	Rosso / Red	Nylon 66	UL94-V2	--
CT1081H	1.000	Neutro / Neutral	Nylon 66	UL94-V2	GWT NoFlame
CT1081V0	1.000	Neutro / Neutral	Nylon 66	UL94-V0	RTI 110
CT1081Z	1.000	Neutro / Neutral	Nylon 66	UL94-V0	GWT NoFlame
CT1081V	1.000	Neutro / Neutral	Nylon 66	UL94-V2	RTI120 - RTI Elec150

SERIE 6,3mm TERMINALI e CONNETTORI .250" TERMINALS and CONNECTORS

CONNETTORE 8 VIE MASCHIO MALE HOUSING 8 WAYS

 UL Recognized

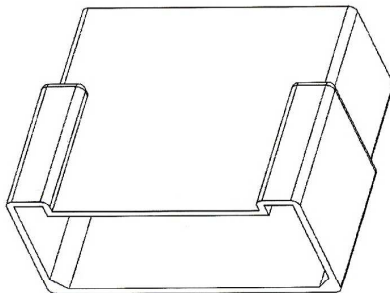

6,3 x 0,8

CODICE Code	CONFEZIONE Package	COLORE Colour	MATERIALE Material	INFIAMMABILITA' Flammability	
CT1083	1.000	Neutro / Neutral	Nylon 66	UL94-V2	--
CT1083-1	1.000	Nero / Black	Nylon 66	UL94-V2	--
CT1083-2	1.000	Rosso / Red	Nylon 66	UL94-V2	--
CT1083H	1.000	Neutro / Neutral	Nylon 66	UL94-V2	GWT NoFlame
CT1083V0	1.000	Neutro / Neutral	Nylon 66	UL94-V0	RTI 110
CT1083Z	1.000	Neutro / Neutral	Nylon 66	UL94-V0	GWT NoFlame
CT1083V	1.000	Neutro / Neutral	Nylon 66	UL94-V2	RTI120 - RTI Elec150

SERIE 6,3mm TERMINALI e CONNETTORI

.250" TERMINALS and CONNECTORS

CONNETTORE 11 VIE FEMMINA

FEMALE 11 WAYS HOUSING

 UL Recognized

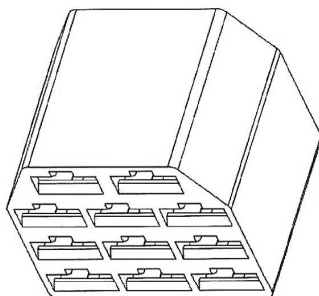

6,3 x 0,8

CODICE Code	CONFEZIONE Package	COLORE Colour	MATERIALE Material	INFIAMMABILITA' Flammability	
CT1110	1.000	Neutro / Neutral	Nylon 66	UL94-V2	--
CT1110-1	1.000	Nero / Black	Nylon 66	UL94-V2	--
CT1110-2	1.000	Rosso / Red	Nylon 66	UL94-V2	--
CT1110H	1.000	Neutro / Neutral	Nylon 66	UL94-V2	GWT NoFlame
CT1110V0	1.000	Neutro / Neutral	Nylon 66	UL94-V0	RTI 110
CT1110Z	1.000	Neutro / Neutral	Nylon 66	UL94-V0	GWT NoFlame
CT1110V	1.000	Neutro / Neutral	Nylon 66	UL94-V2	RTI120 - RTI Elec150

CONNETTORE 8 VIE MASCHIO CON GANCI PER PANNELLO

MALE HOUSING 8 WAYS WITH PANEL MOUNTS

 UL Recognized

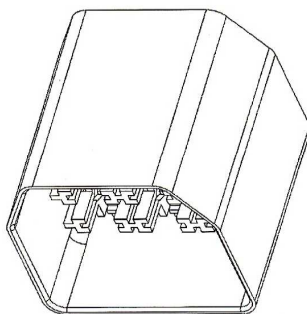

6,3 x 0,8

CODICE Code	CONFEZIONE Package	COLORE Colour	MATERIALE Material	INFIAMMABILITA' Flammability	
CT1111	1.000	Neutro / Neutral	Nylon 66	UL94-V2	--
CT1111-1	1.000	Nero / Black	Nylon 66	UL94-V2	--
CT1111-2	1.000	Rosso / Red	Nylon 66	UL94-V2	--
CT1111H	1.000	Neutro / Neutral	Nylon 66	UL94-V2	GWT NoFlame
CT1111V0	1.000	Neutro / Neutral	Nylon 66	UL94-V0	RTI 110
CT1111Z	1.000	Neutro / Neutral	Nylon 66	UL94-V0	GWT NoFlame
CT1111V	1.000	Neutro / Neutral	Nylon 66	UL94-V2	RTI120 - RTI Elec150

SERIE 6,3mm TERMINALI e CONNETTORI .250" TERMINALS and CONNECTORS

CONNETTORE 10 VIE FEMMINA Adatto al Timer Elbi FEMALE HOUSING 10 WAYS Mating Elbi Timer

 UL Recognized

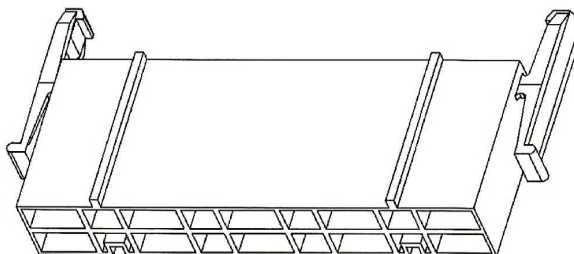

6,3 x 0,8

CODICE Code	CONFEZIONE Package	COLORE Colour	MATERIALE Material	INFIAMMABILITA' Flammability	
CT5010	1.250	Neutro / Neutral	Nylon 66	UL94-V2	--
CT5010-1	1.250	Nero / Black	Nylon 66	UL94-V2	--
CT5010-2	1.250	Rosso / Red	Nylon 66	UL94-V2	--
CT5010H	1.250	Neutro / Neutral	Nylon 66	UL94-V2	GWT NoFlame
CT5010V0	1.250	Neutro / Neutral	Nylon 66	UL94-V0	RTI 110
CT5010Z	1.250	Neutro / Neutral	Nylon 66	UL94-V0	GWT NoFlame
CT5010V	1.250	Neutro / Neutral	Nylon 66	UL94-V2	RTI120 - RTI Elec150

CONNETTORE 5 VIE FEMMINA Adatto al Timer Elbi FEMALE HOUSING 5 WAYS Mating Elbi Timer

 UL Recognized

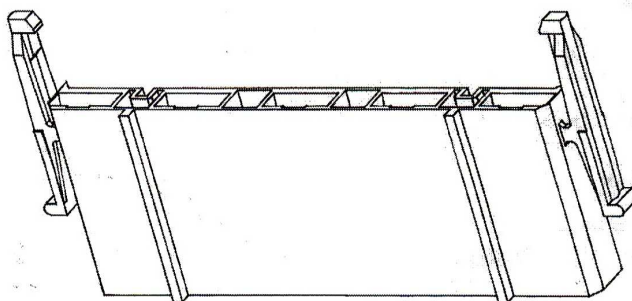

6,3 x 0,8

CODICE Code	CONFEZIONE Package	COLORE Colour	MATERIALE Material	INFIAMMABILITA' Flammability	
CT5005	1.250	Neutro / Neutral	Nylon 66	UL94-V2	--
CT5005-1	1.250	Nero / Black	Nylon 66	UL94-V2	--
CT5005-2	1.250	Rosso / Red	Nylon 66	UL94-V2	--
CT5005H	1.250	Neutro / Neutral	Nylon 66	UL94-V2	GWT NoFlame
CT5005V0	1.250	Neutro / Neutral	Nylon 66	UL94-V0	RTI 110
CT5005Z	1.250	Neutro / Neutral	Nylon 66	UL94-V0	GWT NoFlame
CT5005V	1.250	Neutro / Neutral	Nylon 66	UL94-V2	RTI120 - RTI Elec150

SERIE 6,3mm TERMINALI e CONNETTORI .250" TERMINALS and CONNECTORS

CONNETTORE 10 VIE FEMMINA Adatto al Timer Copreci FEMALE HOUSING 10 WAYS Mating Copreci Timer

 UL Recognized

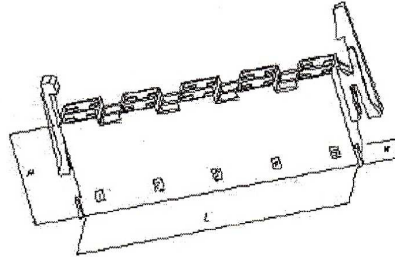

6,3 x 0,8

CODICE Code	CONFEZIONE Package	COLORE Colour	MATERIALE Material	INFIAMMABILITA' Flammability	
C5C010	1.250	Neutro / Neutral	Nylon 66	UL94-V2	--
C5C010-1	1.250	Nero / Black	Nylon 66	UL94-V2	--
C5C010-2	1.250	Rosso / Red	Nylon 66	UL94-V2	--
C5C010H	1.250	Neutro / Neutral	Nylon 66	UL94-V2	GWT NoFlame
C5C010V0	1.250	Neutro / Neutral	Nylon 66	UL94-V0	RTI 110
C5C010Z	1.250	Neutro / Neutral	Nylon 66	UL94-V0	GWT NoFlame
C5C010V	1.250	Neutro / Neutral	Nylon 66	UL94-V2	RTI120 - RTI Elec150

CONNETTORE PORTAFUSIBILI MODULARE MODULAR CONNECTOR FOR FUSE

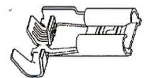
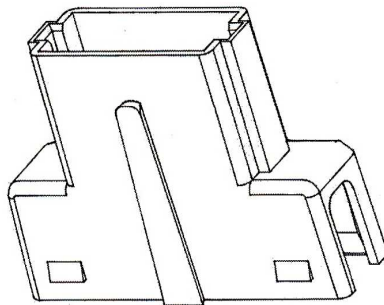

6,3 x 0,8

CODICE Code	CONFEZIONE Package	COLORE Colour	MATERIALE Material	INFIAMMABILITA' Flammability	
PF5301	5.000	Neutro / Neutral	Nylon 66	UL94-V2	--
PF5301-1	5.000	Nero / Black	Nylon 66	UL94-V2	--
PF5301V0	5.000	Neutro / Neutral	Nylon 66	UL94-V0	RTI 110
PF5301V0-1	5.000	Nero / Black	Nylon 66	UL94-V0	RTI 110