

## **NECTOR S Line** lighting components

Flexible solutions for your lighting designs





The lighting industry is always changing. It is constantly in pursuit of more energy-efficient products with longer life-spans that can be used in different places under different circumstances. **TE Connectivity can assist developers, designers and innovators in gaining a head start in this competitive industry.** For over 60 years we have worked with lighting industry leaders providing them with strong competitive advantages. Today, with over 500,000 part numbers, we are a leader in passive electronic components. Tomorrow we can apply our expertise to your design and development programs.



## NECTOR S Line

The Nector S Line connector is a small, power-to-luminaire connector designed to meet the lighting industry's need for a compact, easy-to-install interconnect solution. This 7.5mm connector can easily fit in an 8 mm opening compared to other connectors that require much larger openings. The Nector S Line connector is ideal for applications where a power connection and coupling between lamps is needed. Targeted applications include lighting wiring in offices, kitchens, bathrooms, display cabinets, mountable lightings, shop and household furniture.

Whether it's showing you our value-added solutions or designing a new product; our commitment to advanced engineering and world-class manufacturing delivers innovation to advance your lighting project.

A grid of 20 jewelry display cases arranged in a 4x5 pattern. Each case contains a necklace on a mannequin. The necklaces vary in design, including multi-strand beaded necklaces, pearl necklaces, and necklaces with large pendants. The cases are illuminated from above, highlighting the jewelry. The word "seeing" is overlaid in white text on the right side of the grid.

seeing

**actual hole size**  
fits a 7.5mm connector



# is believing

## Lighting solutions that increase sales

### Products need to stand out

Every product deserves the best presentation possible. Not only in a photograph used for an advertisement, but in its display at a store, a product fair or in the reseller's showroom. Most of the lighting featured in such product presentations should showcase the product in the most optimal way.

**THE PROBLEM :** An unreliable lighting connection can lead to light failure, which in turn can lead to poor product presentation.

**OUR SOLUTION :** A **reliable** lighting fixture with a proven connector system.

**THE END RESULT :** A **flexible**, high-quality fixture that provides more value through an integrated connector system.

### We can make your product stand out

Now you can have a plug-and-play interconnection system that easily conducts power anywhere. With the NECTOR S Line connector, you are no longer limited by the size and shape of a connector. The small, smart wiring solution can make the presentation of any product outstanding.

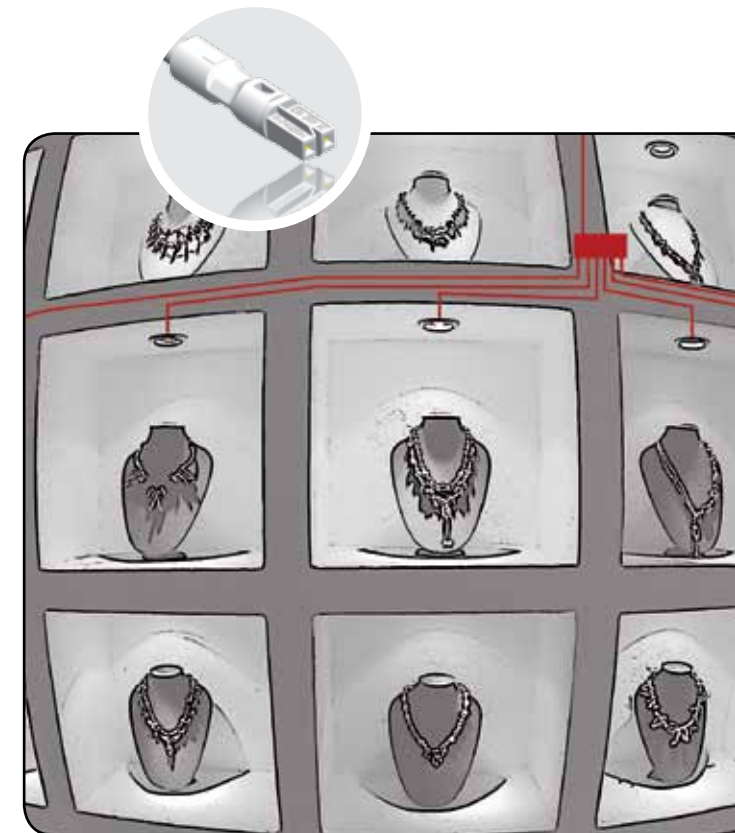

- Expand the power system and easily split power for two lamps
- Splitter has the function to switch power
- LEDs can be placed in the series using a splitter



Plug-and-play principle.

**actual hole size**  
fits a 7.5mm connector

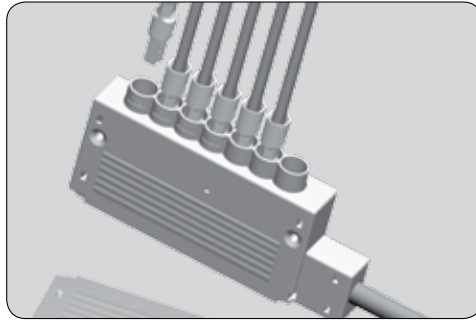

# It's easy and reliable.

**Easy. Fast. Compact.**

It's our job to make lighting connectors easy to use and fast to implement. The compact NECTOR S Line connector allows you to think freely with your lighting design as its flexibility enables you to move fixtures around product displays for optimum lighting without worrying about any practical implications.

**Our connectors can make your lighting visualizations a reality.**



A modern kitchen with a curved ceiling, recessed lighting, and a dining table with four chairs. The kitchen features white cabinetry, a stainless steel range hood, and a countertop with various appliances. The dining area has a glass table and four white chairs. The lighting is warm and focused, highlighting the kitchen and dining areas.

lighting as you

**actual hole size**  
fits a 7.5mm connector



# imagined it

Flexible solutions with every design.

## The creative use of light sources

Every interior designer knows what proper lighting can do to a room, a desk or a cabinet. It can set a room's ambiance, tone a wall color, or apply an accent on just the right spot. Your wiring can be just as **flexible** as your imagination.

## Just give us 8mm

If you give us an opening as little as 8mm, the NECTOR S Line connector can fit there. You can power your lights just about anywhere: in a cabinet, inside kitchen furniture or in a headboard. The connector is easy to use, fast to implement and small enough to fit almost anywhere.



- Six-way splitter to power six lamps
- Optional switch function to switch distributor on or off



Better Atmosphere.

**actual hole size**  
fits a 7.5mm connector

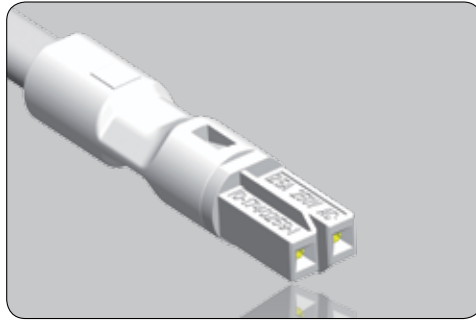
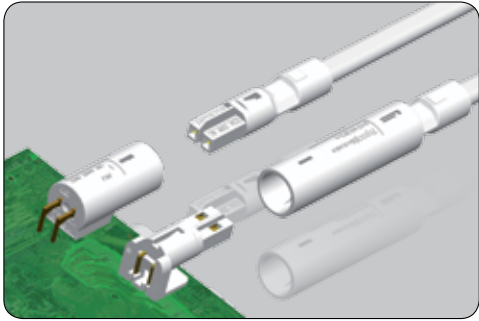

# Electricity where you need it.

## It's the little things

The overall atmosphere of any interior lighting design can change because of a 7.5mm connector. Those few millimeters can give you unparalleled freedom to power your lights. Whether it is 250V, 125V or a low voltage, the plug-and-play connector can expand a lighting system beyond its wall outlet.



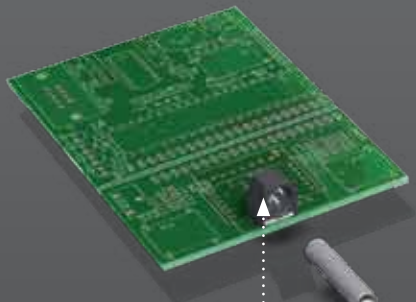

• SMD mount for soldering direct on drive

- Male-male cable
- Plug and play

• Extension cable optional

• Same SMD connector as on driver



Color control.

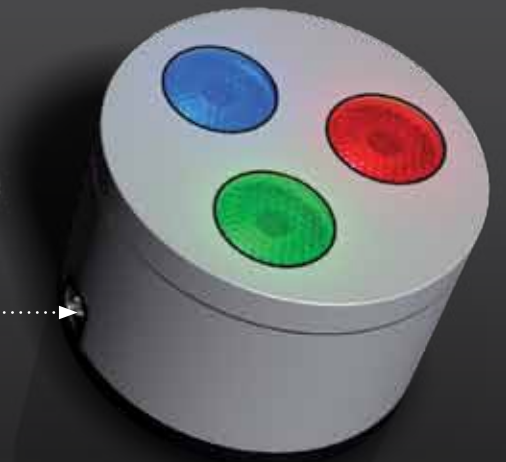

**actual hole size**  
fits a 7.5mm connector

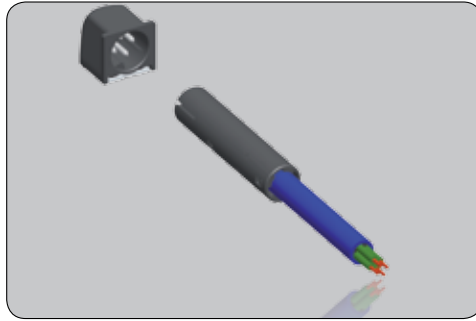
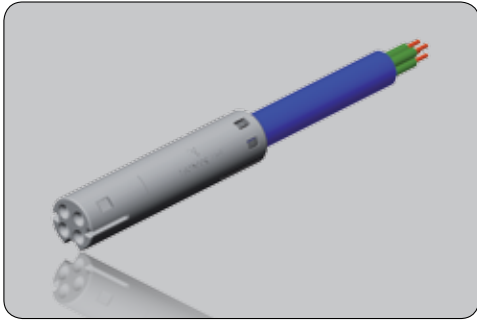

## 4 pole connector for control applications.

### **If you need more control.**

In many applications you like extra wires for control applications. This 4 pole connector fits through the same hole size diameter as the 2-pole NECTOR S line connector. The same small size is suitable for low voltage applications such as dimming or color control. The 4 pole series includes a SMD connector for pcb mounting and a male and female connector on wire.

Standard cable assemblies for coupling are available in 50 centimeter intervals up to 2.5 (meters) and from 2 feet up to 16 feet in two foot intervals.

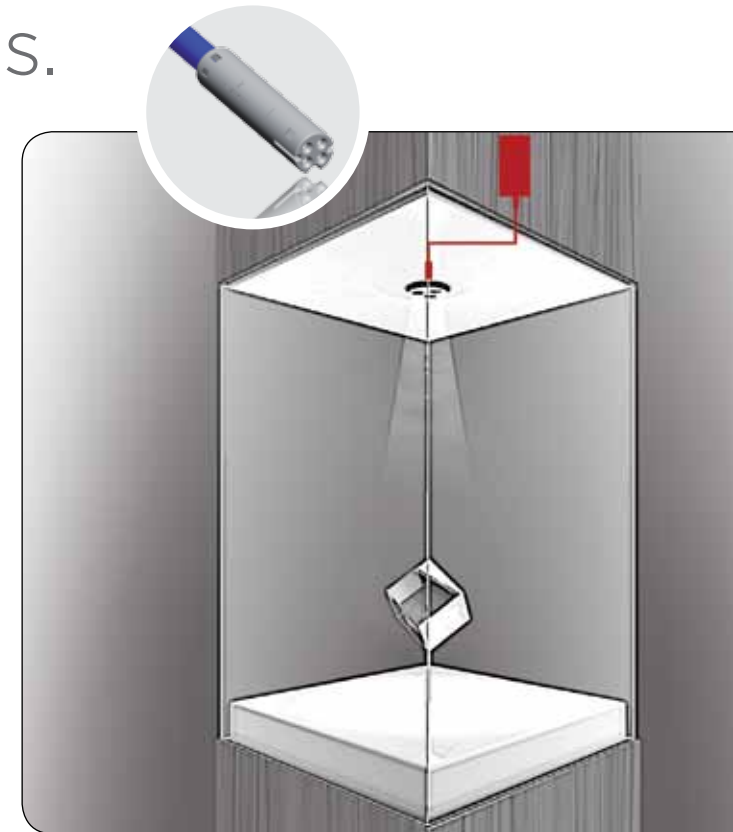

A photograph of a shopping cart in a grocery store aisle. The cart is in the foreground on the right, with a white handle and a blue grip. The aisle is filled with shelves of various products, including colorful packages and fresh produce, extending into the background. The lighting is bright, typical of a supermarket.

small connectors,

**actual hole size**  
fits a 7.5mm connector



# optimal connectivity

## Freedom in energy distribution.

### **Less use of space, energy, and design equals better lighting installations.**

With the development of LEDs, lighting fixtures are now smaller in size and the possibilities of lighting are expanding. The NECTOR S Line connector can power small fixtures that are designed to fit into almost any space.

### **Our connector goes places**

Well balanced lighting inside a refrigerator or freezer system can increase sales. Products are more noticeable, more appealing and consequently they sell better. When you use the NECTOR S Line connector to power the lights inside your current conventionally-lit freezer or refrigerator case, you have the flexibility to quickly and easily change to a new LED lighting system.

In refrigerator or freezer applications, the sealed NECTOR S Line connector is easy to use. In both new and retrofit installations, its small size makes it almost invisible. The sealed NECTOR S Line connector system includes a range of easy-to-install, flexible products specifically designed for commercial refrigeration and freezer systems.

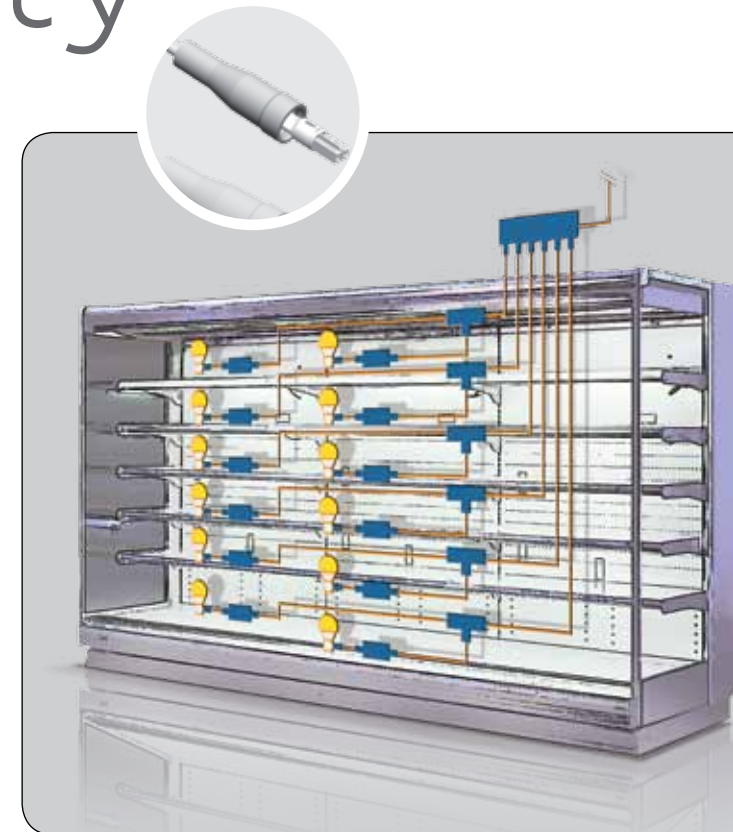

- Bus bar can be placed anywhere on the cable
- Multiple bus bars can be placed on the cable
- Sealed bus bar and sealed plug provide IP67 protection



Displays in a whole new light.

**actual hole size**  
fits a 7.5mm connector

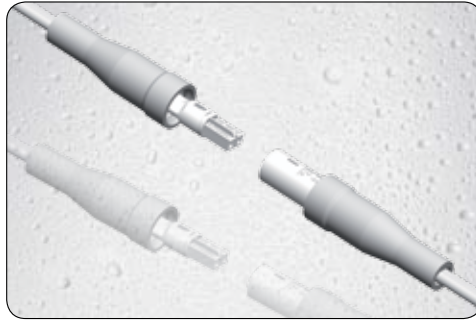
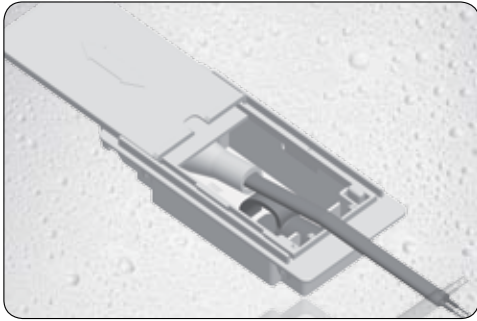

## Upgrade your inventory.

### What you see is what you get

Customers want to take a good look at the products they are about to purchase. Supermarkets and department stores pay close attention to their overall use of lighting to ensure that the products on their shelves are noticeable. With refrigeration and freezer systems, good lighting is never easy to achieve. New systems are equipped with interior lighting that is optimized. Retrofitting an existing lighting system is a costly operation often not done unless other upgrades are needed.

### Upgrade now

When you use the NECTOR S Line connector to retrofit the lighting inside your current system, you have the opportunity to use the latest in interconnect and lighting technology. Not only will the products on your shelves look and sell better, but your store will look better too!



# NECTOR S Line Product details



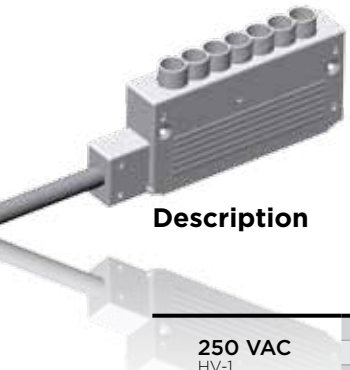

## Cable Assembly Euro Style Cable

te.com/lighting

Cable Color ● Black ○ White



### Description

Description		S Line Plug to Outlet	S Line Plug to Pigtail	S Line Outlet to Pigtail
<b>250 VAC</b> HV-1  Max. 2.5 Amp.	0.5m	1-2083029-1 ●	1-2083031-1 ●	1-2083033-1 ●
	1m	1-2083029-2 ●	1-2083031-2 ●	1-2083033-2 ●
	1.5m	1-2083029-3 ●	1-2083031-3 ●	1-2083033-3 ●
	2m	1-2083029-4 ●	1-2083031-4 ●	1-2083033-4 ●
	0.5m	1-2083029-5 ○	1-2083031-5 ○	1-2083033-5 ○
	1m	1-2083029-6 ○	1-2083031-6 ○	1-2083033-6 ○
	1.5m	1-2083029-7 ○	1-2083031-7 ○	1-2083033-7 ○
	2m	1-2083029-8 ○	1-2083031-8 ○	1-2083033-8 ○
<b>250 VAC</b> HV-2 (switch)  Max. 2.5 Amp.	0.5m		2-2083031-1 ●	
	1m		2-2083031-2 ●	
	1.5m		2-2083031-3 ●	
	2m		2-2083031-4 ●	
	0.5m		2-2083031-5 ○	
	1m		2-2083031-6 ○	
	1.5m		2-2083031-7 ○	
	2m		2-2083031-8 ○	
<b>42 VAC</b> LV-1  Max. 7 Amp.	0.5m	1-2083030-1 ●	1-2083032-1 ●	1-2083034-1 ●
	1m	1-2083030-2 ●	1-2083032-2 ●	1-2083034-2 ●
	1.5m	1-2083030-3 ●	1-2083032-3 ●	1-2083034-3 ●
	2m	1-2083030-4 ●	1-2083032-4 ●	1-2083034-4 ●
	0.5m	1-2083030-5 ○	1-2083032-5 ○	1-2083034-5 ○
	1m	1-2083030-6 ○	1-2083032-6 ○	1-2083034-6 ○
	1.5m	1-2083030-7 ○	1-2083032-7 ○	1-2083034-7 ○
	2m	1-2083030-8 ○	1-2083032-8 ○	1-2083034-8 ○
<b>42 VDC</b> LV-2  Max. 7 Amp.	0.5m	2-2083030-1 ●	2-2083032-1 ●	2-2083034-1 ●
	1m	2-2083030-2 ●	2-2083032-2 ●	2-2083034-2 ●
	1.5m	2-2083030-3 ●	2-2083032-3 ●	2-2083034-3 ●
	2m	2-2083030-4 ●	2-2083032-4 ●	2-2083034-4 ●
	0.5m	2-2083030-5 ○	2-2083032-5 ○	2-2083034-5 ○
	1m	2-2083030-6 ○	2-2083032-6 ○	2-2083034-6 ○
	1.5m	2-2083030-7 ○	2-2083032-7 ○	2-2083034-7 ○
	2m	2-2083030-8 ○	2-2083032-8 ○	2-2083034-8 ○

	S Line 6 Way Distributor Pigtail	S Line 6 Way Distributor Pigtail (switchable)
1m	1-2083038-1 ●	
1m	1-2083038-2 ○	
1m		1-2083040-1 ●
1m		1-2083040-2 ○
1m	1-2083039-1 ●	1-2083041-1 ●
1m	1-2083039-2 ○	1-2083041-2 ○
1m	2-2083039-1 ●	2-2083041-1 ●
1m	2-2083039-2 ○	2-2083041-2 ○

	S Line Outlet to Europlug	S Line 6 Way distributor to Europlug	S Line 6 Way Distributor to Europlug (switchable)
1.8m	1-2083035-1 ●	1-2083036-1 ●	
1.8m	1-2083035-2 ○	1-2083036-2 ○	
1.8m			1-2083037-1 ●
1.8m			1-2083037-2 ○

**actual hole size**  
fits a 7.5mm connector





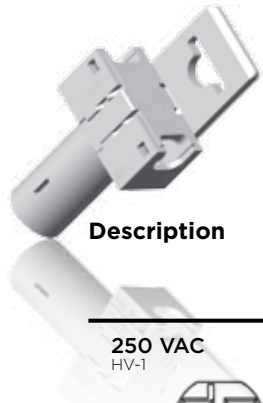

## Standard Components Euro Style

[te.com/lighting](http://te.com/lighting)



**Housing Color** ● Black ○ White ○ Light Grey ● Yellow T Transparent ● Red

Description	Bus Bar With Fixing Hook		Bus Bar Without Fixing Hook		Splitter Parallel		Splitter Serial		Outlet PCB Connector (straight version)		Outlet PCB Connector (straight angled version)		Plug PCB Connector (straight version)		Plug PCB Connector (straight angled version)	
	Part No.	Color	Part No.	Color	Part No.	Color	Part No.	Color	Part No.	Color	Part No.	Color	Part No.	Color	Part No.	Color
<b>250 VAC</b> HV-1 	293300-1	○	293300-3	○	293234-3	○			293313-1	○	293315-1	○	293308-1	○	293311-1	○
	293300-2	●	293300-4	●	293234-9	●			293313-2	●	293315-2	●	293308-2	●	293311-2	●
	293270-1 <sup>1</sup>	○	293270-3 <sup>1</sup>	○					293313-9 <sup>3</sup>	○	293315-6 <sup>3</sup>	○				
	293270-2 <sup>2</sup>	○	293270-4 <sup>2</sup>	○					1-293313-0 <sup>3</sup>	●	293315-7 <sup>3</sup>	●				
<b>250 VAC</b> HV-2 (switch) 									293313-8	●			293308-4	●	293311-4	●
<b>42 VAC</b> LV-1 	293300-9	○	1-293300-0	○	293234-7	○			293313-4	○	293315-4	○	293308-5	○	293311-5	○
<b>42 VDC</b> LV-2 	1-293300-1	●	1-293300-2	●	293234-8	●	293235-4 (LV2(LV2-LV2))	●	293313-5	●	293315-5	●	293308-6	●	293311-6	●
	293270-5 <sup>1</sup>		293270-7 <sup>1</sup>	●												
	293270-6 <sup>2</sup>		293270-8 <sup>2</sup>	●												

1: feed through sealed 2: end run sealed 3: gold plated contact

# NECTOR S Line Product details

TOOLING	
Handtool for LP Crimp contacts (complete tool)	2-1579004-2
Handgripper for Crimphead + Crimphead for LP Crimpcontacts (both parts needed)	2-1579005-1 3-1579021-8
Applicator for ST Crimpcontacts	9-541803-2
To be used on machine	1725950-6
Handtool for ring clip	3-1579002-1
Contact Extraction tool	1-1579007-4

## Loose Piece Components Euro style

NECTOR S Line is acc IEC 60320. For more technical specifications go to [te.com/lighting](http://te.com/lighting)



Description	Outlet Housing (to be used with pin contact)	Pin Contact	Tube H03 VVH2	Ring Clip	Plug Housing (to be used with socket contact)	Socket Contact	Tube H03 VVH2	Ring Clip	Panel Mount Outlet (to be used with pin contact)	Pin Contact
250 VAC HV-1	1740262-1 ○				1740259-1 ○					
	1740262-2 ●				1740259-2 ●					
250 VAC HV-2 (switch)		1740335-1 (unplated) 1740335-4 (tin plated)	1740260-1 ○ 1740260-2 ●	1740261-1 ○ 1740261-2 ●	1740259-5 ●	1740336-1 (unplated) 1740336-4 (tin plated)	1740260-1 ○ 1740260-2 ●	1740261-1 ○ 1740261-2 ●		1740335-1 (unplated) 1740335-4 (tin plated) 1740335-7 (gold plated)
	42 VAC LV-1				1740451-1 ○					
42 VDC LV-2	1740451-2 ●									

Description	6 Way Distributor Body	Cover	6 Way Distributor Body (switchable, to be used with coding ring)	Coding Ring	Cover	IP Boot (to be used on plug and outlet)	Wall Outlet Assembly (inclusive blind boot)	Wall Outlet Frame Assembly	Chassis Mount Frame (Panel thickness 0.5mm to 1.5mm)	Chassis Mount Housing Support (to be used with chassis mount frame)
250 VAC HV-1	1740317-1 ○									
	1740317-3 ●									
250 VAC HV-2 (switch)										
42 VAC LV-1	1740317-7 ○									
42 VDC LV-2	1740317-9 ●									

**actual hole size**  
fits a 7.5mm connector



## 4 Pole Version Euro style

NECTOR S Line is acc IEC 60320. For more technical specifications go to [te.com/lighting](http://te.com/lighting)



### Connectors

	 PCB	 Male (socket) Kit For Pins (to be used with pin contact)	 Female (plug) Kit For Socket (to be used with socket contact)
Key Gray		293412-3	293411-3
Key White	293415-1	293412-1	293411-1
Key Black	293415-2	293412-2	293411-2



Pin contact



Socket contact

Tool

	Pin contact	Socket contact	Tool
Loose piece	166293-1	166291-1	169341-1 or 91503-1
Small reel for reel fed Hand tool	5-166053-1	5-166051-1	169424-1
Large reel for applicator	166053-1	166051-1	SC-15 (on request)

### Cable Assembly - 4 Pole

#### Female - Female

0.5m	1-2083115-1	●
1m	1-2083115-2	●
1.5m	1-2083115-3	●
2m	1-2083115-4	●
2.5m	1-2083115-5	●
0.5m	2-2083115-1	○
1m	2-2083115-2	○
1.5m	2-2083115-3	○
2m	2-2083115-4	○
2.5m	2-2083115-5	○

### Cable Assembly - 4 Pole

#### Male - Female

2m	1-2083116-1	●
4m	1-2083116-2	●
2m	2-2083116-1	○
4m	2-2083116-2	○

# NECTOR S Line Product details



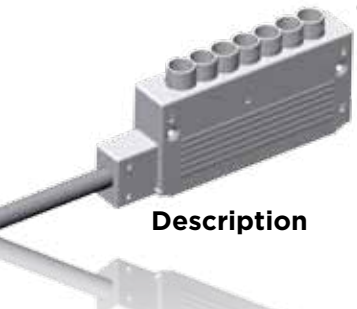

## Cable Assemblies UL Style Cable

te.com/lighting

Cable assemblies will be made with **SVT** cable



Cable Color ○ White

Description	S Line Plug to Pigtail			S Line 6 Way Distributor Pigtail					S Line 6 Way Distributor to Powerplug					NS Line 6 Way distributor to Powerplug (switchable)											
	2ft	4ft	6ft	8ft	10ft	12ft	14ft	16ft	2ft	4ft	6ft	8ft	10ft	12ft	14ft	16ft	2ft	4ft	6ft	8ft	10ft	12ft	14ft	16ft	
<b>125 VAC</b> switch lead HV-2 Max. 6 Amp. 	2ft			2-2083074-1	○																				
	4ft			2-2083074-2	○																				
	6ft			2-2083074-3	○																				
	8ft			2-2083074-4	○																				
	10ft			2-2083074-5	○																				
	12ft			2-2083074-6	○																				
	14ft			2-2083074-7	○																				
	16ft			2-2083074-8	○																				
<b>125 VAC</b> HV-3 Max. 6 Amp. 	2ft	1-2083073-1	○	1-2083075-1	○	1-2083077-1	○																		
	4ft	1-2083073-2	○	1-2083075-2	○	1-2083077-2	○																		
	6ft	1-2083073-3	○	1-2083075-3	○	1-2083077-3	○																		
	8ft	1-2083073-4	○	1-2083075-4	○	1-2083077-4	○	1-2083078-1	○																
	10ft	1-2083073-5	○	1-2083075-5	○	1-2083077-5	○																		
	12ft	1-2083073-6	○	1-2083075-6	○	1-2083077-6	○																		
	14ft	1-2083073-7	○	1-2083075-7	○	1-2083077-7	○																		
	16ft	1-2083073-8	○	1-2083075-8	○	1-2083077-8	○																		
<b>125 VAC</b> HV-4 Max. 6 Amp. 	2ft	1-2083072-1	○	1-2083074-1	○	1-2083076-1	○																		
	4ft	1-2083072-2	○	1-2083074-2	○	1-2083076-2	○																		
	6ft	1-2083072-3	○	1-2083074-3	○	1-2083076-3	○																		
	8ft	1-2083072-4	○	1-2083074-4	○	1-2083076-4	○																		
	10ft	1-2083072-5	○	1-2083074-5	○	1-2083076-5	○																		
	12ft	1-2083072-6	○	1-2083074-6	○	1-2083076-6	○																		
	14ft	1-2083072-7	○	1-2083074-7	○	1-2083076-7	○																		
	16ft	1-2083072-8	○	1-2083074-8	○	1-2083076-8	○																		
<b>42 VDC</b> LV-2 Max. 7 Amp. 	2ft	2-2083073-1	○	2-2083075-1	○	2-2083077-1	○																		
	4ft	2-2083073-2	○	2-2083075-2	○	2-2083077-2	○																		
	6ft	2-2083073-3	○	2-2083075-3	○	2-2083077-3	○																		
	8ft	2-2083073-4	○	2-2083075-4	○	2-2083077-4	○																		
	10ft	2-2083073-5	○	2-2083075-5	○	2-2083077-5	○																		
	12ft	2-2083073-6	○	2-2083075-6	○	2-2083077-6	○																		
	14ft	2-2083073-7	○	2-2083075-7	○	2-2083077-7	○																		
	16ft	2-2083073-8	○	2-2083075-8	○	2-2083077-8	○																		

**actual hole size**  
fits a 7.5mm connector













## Standard Components UL Style

For more technical specifications go to [te.com/lighting](http://te.com/lighting)



**Description**

**Housing Color** ○ White

	 Splitter Parallel	 Splitter Serial	 Outlet PCB Connector straight version	 Outlet PCB Connector straight angled version	 Plug PCB Connector straight version	 Plug PCB Connector straight angled version
<b>125 VAC</b> HV-2 (switc 		293649-1 (HV4-(HV4/HV2)) ○ 293649-2 (LV2-(LV2/HV2)) ○	293653-1 ○	293652-1 ○	293655-1 ○	293654-1 ○
<b>125 VAC</b> HV-3 	293650-2 ○		293653-2 ○	293652-2 ○	293655-2 ○	293654-2 ○
<b>125 VAC</b> HV-4 	293650-1 ○	293649-1 (HV4-(HV4/HV2)) ○	293653-3 ○	293652-3 ○	293655-3 ○	293654-3 ○
<b>125 VAC</b> HV-5 	293650-3 ○		293653-4 ○	293652-4 ○	293655-4 ○	293654-4 ○
<b>42 VDC</b> LV-2 	293650-4 ○	293649-2 (LV2-(LV2/HV2)) ○	293653-5 ○	293652-5 ○	293655-5 ○	293654-5 ○

# NECTOR S Line Product details

TOOLING	Handtool for LP Crimp contacts (complete tool)	2-1579004-2
	Handgripper for Crimphead + Crimphead for LP Crimpcontacts (both parts needed)	2-1579005-1 3-1579021-8
	Applicator for ST Crimpcontacts	9-541803-2
	To be used on machine	1725950-6
	Handtool for ring clip	3-1579002-1
Contact Extraction tool	1-1579007-4	

## Loose Piece Components UL style

For more technical specifications go to [te.com/lighting](http://te.com/lighting)



Description	Outlet Housing (to be used with pin contact)	Pin Contact (tin plated)	Tube SVT Style Cable	Plug Housing (to be used with socket contact)	Socket Contact (tin plated)	Tube SVT Style Cable	Panel Mount Outlet (to be used with pin contact)	Pin Contact (tin plated)	Tube SPT-2 Style Cable (alternative for tube SVT)	
125 VAC HV-2 (switch)				293388-1	○					
125 VAC HV-3	293387-1	○		293388-2	○					
125 VAC HV-4	293387-2	○	293389-1	293388-2	○	293390-1	293359-1	293648-1	○	293358-1
125 VAC HV-5	293387-3	○		293388-4	○					
42 VDC LV-2	293387-4	○		293388-5	○			293648-2	○	

Description	6 Way Distributor Body (switchable, to be used with coding ring)	Coding Ring	Cover	6 Way Distributor Body	Cover	Bridge Connector	
125 VAC HV-2 (switch)							
125 VAC HV-3	293651-2 (HV3 (6X) + HV2)	○		293651-1	○		
125 VAC HV-4		1740316-1	293587-1		293587-1	293647-1 (HV4-HV5)	○
125 VAC HV-5						293647-1 (HV4-HV5)	○
42 VDC LV-2	293651-4 (LV2 (6X) + HV2)	○		293651-3	○		

**actual hole size**  
fits a 7.5mm connector



## 4 Pole Version UL Style

For more technical specifications go to [te.com/lighting](http://te.com/lighting)

	<b>PCB</b>	<b>Male (socket) Kit for Pins</b> (to be used with pin contact)	<b>Female (plug) Kit for Socket</b> (to be used with socket contact)
Key Gray		293703-3	293702-3
Key White	293415-1	293703-1	293702-1
Key Black	293415-2	293703-2	293702-2

Note that Grey key is different from Black & White

	<b>Pin Contact</b>	<b>Socket Contact</b>	<b>Tool</b>
Loose piece	166293-1	166291-1	169341-1 or 91503-1
Small reel for reel fed Hand tool	5-166053-1	5-166051-1	169424-1
Large reel for applicator	166053-1	166051-1	SC-15 (on request)

<b>Cable Assembly - 4 pole</b>	<b>Female - Female</b>	
2ft	1-2083135-1	●
4ft	1-2083135-2	●
8ft	1-2083135-3	●
12ft	1-2083135-4	●
16ft	1-2083135-5	●
2ft	2-2083135-1	○
4ft	2-2083135-2	○
8ft	2-2083135-3	○
12ft	2-2083135-4	○
16ft	2-2083135-5	○

	<b>Male - Female</b>	
8ft	1-2083136-1	●
12ft	1-2083136-2	●
8ft	2-2083136-1	○
12ft	2-2083136-2	○

# NECTOR S Line Product details

## TE Connectivity Assembly Instructions

[te.com/lighting](http://te.com/lighting)

### Assembly Instructions Euro Style



**Step 1**  
Slide the tube on the cable.



**Step 2**  
Crimp the contacts on the wire.



**Step 3**  
Slide the housing on the contacts.



**Step 4**  
Slide the tube on the housing.



**Step 5**  
Position the ringclip on the tube and push.



**Ready!**  
Remove the ringclip strain.

### Assembly Instructions UL Style SVT



**Step 1**  
Slide the tube on the cable.



**Step 2**  
Crimp the contacts on the wire.



**Step 3**  
Slide the housing on the contacts.



**Step 4**  
Slide the tube on the housing.

### Technical Documents : Nector S Line

	Euro style	UL style
Product specification	108-94018	108-20294
Application specification	114-18751	114-20140
Approvals	DIN EN IEC 60320 (VDE)	UL1977

### Assembly Instructions SPT-2



**Step 1**  
Slide the tube on the cable.



**Step 2**  
Crimp the contacts on the wire.



**Step 3**  
Slide the housing on the contacts.



**Step 4**  
Slide the tube on the housing.

# TE Connectivity Product Overview

[te.com/lighting](http://te.com/lighting)



## Nector M Line Connectors

- For fast and flexible installation of power to luminary and general electrical installation
- Small size < 15mm diameter
- UL & Kema approvals pending
- Can be applied to harmonized H05VVF 3\* 1.5 & 3\* 2.5mm 2 cable



## CoolSplice Connectors

- A series of insulation displacement connectors (IDC) to make connecting of wire-to-wire simple.
- Available in standard version and for flat ribbon cable
- Optional IP 65 & 67 sealing (IP66 for flat ribbon cable version)
- Suitable up to 2.5 Amp/230V



## Solid State Lighting (SSL) IDC Connectors

- Connects strings of printed circuit board LED light modules
- Available in 1, 2, 3 and 4 positions
- Closed-end and feed-through connector styles
- 18-24 AWG stranded and solid wire



## Hermaphroditic Blade and Receptacle Connectors

- Available in 2, 4, and 6 positions
- Connector mates to itself
- Connector mates and unmates horizontally and vertically -3 axis mating
- Connector can be articulated from 90° to 180°

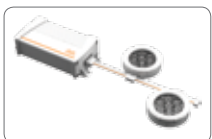

## NEVALO SSL System

- Plug and play system integrates LED Light modules (LLMs), cable assemblies and drivers
- Available in lumen outputs ranging from 300-3400+ lumens in multiple CCTs
- Design tools including thermal software, color coding and an SSL system budget



## SlimSeal Solid State Lighting (SSL) Connectors

- Low profile, protected latch
- Polarized housings
- Positive latching to prevent unmating



[nevalo.com](http://nevalo.com)



## FOR MORE INFORMATION

[te.com/lighting](http://te.com/lighting)

### TE Technical Support

Internet:	<a href="http://te.com/help">te.com/help</a>
USA:	+1 (800) 522-6752
Canada:	+1 (905) 475-6222
Mexico:	+52 (0) 55-1106-0800
Latin/South America:	+54 (0) 11-4733-2200
Germany:	+49 (0) 6251-133-1999
UK:	+44 (0) 800-267266
France:	+33 (0) 1-3420-8686
Netherlands:	+31 (0) 73-6246-999
China:	+86 (0) 400-820-6015

Part numbers in this brochure are RoHS Compliant\*, unless marked otherwise.

\*as defined at [te.com/leadfree](http://te.com/leadfree)

## te.com

© 2011 Tyco Electronics Corporation, a TE Connectivity Ltd. company. All Rights Reserved.  
1773457-7 CIS EMEA 500 04/2011

NECTOR, TE Connectivity, TE connectivity (logo) and TE (logo) are trademarks.

Other logos, products and/or company names might be trademarks of their respective owners.

---

While TE has made every reasonable effort to ensure the accuracy of the information in this brochure, TE does not guarantee that it is error-free, nor does TE make any other representation, warranty or guarantee that the information is accurate, correct, reliable or current. TE reserves the right to make any adjustments to the information contained herein at any time without notice. TE expressly disclaims all implied warranties regarding the information contained herein, including, but not limited to, any implied warranties of merchantability or fitness for a particular purpose. The dimensions in this catalog are for reference purposes only and are subject to change without notice. Specifications are subject to change without notice. Consult TE for the latest dimensions and design specifications.

